

Electro-Pneumatic Regulator / High Flow Rate

New



For the stepless control of air pressure in proportion to electrical signals

IP65

High flow rate

Max. approx. **5 times**

(ITV1100) Compared with the existing model

Lightweight

Max. **19%** reduction

(ITV2100) Compared with the existing model

Series Variations

Model	Set pressure range [MPa]	Max. flow rate [L/min (ANR)]*1	Port size (Rc, NPT, G)
ITV1100	0.005 to 0.1	800	1/8, 1/4
ITV2100	0.005 to 0.5	2190	1/4, 3/8
ITV3100	0.005 to 0.9	4400	1/4, 3/8, 1/2

*1 Supply pressure: 0.7 MPa, Set pressure: 0.5 MPa



ITV1100

ITV2100

ITV3100

ITV1100/2100/3100 Series



CAT.ES60-28A

For the stepless control of air pressure in proportion to electrical signals

Multi-step Pressure Control

A single electro-pneumatic regulator can do the work of multiple regulators.

Preset input (4 points) is also possible.

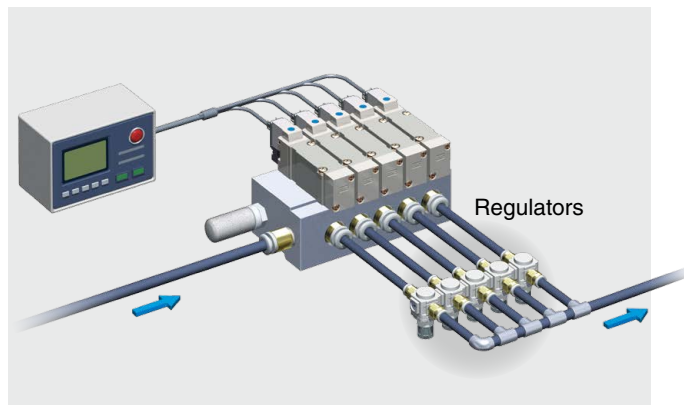
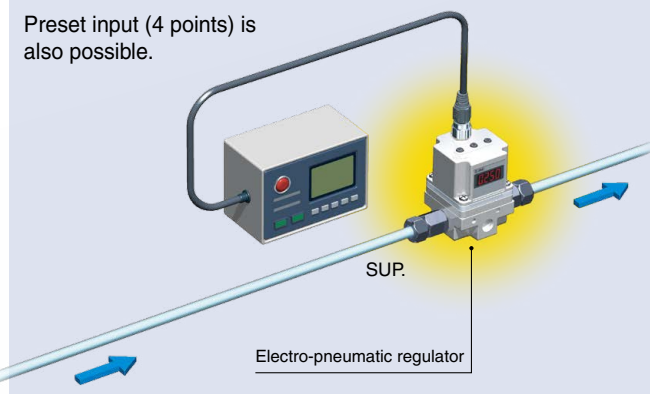

Lightweight

Max. **19%** reduction

Size	High flow rate [g]	Existing model	Reduction rate
ITV1100	235	250	6%
ITV2100	285	350	19%
ITV3100	555	645	14%

* SMC comparison

Compact

Height: **Max. 10 mm***1, *2 shorter

*1 For the ITV2100/3100

*2 Excludes the connector



- Sensitivity: $\pm 0.2\%$ F.S. or less
- Linearity: $\pm 1\%$ F.S. or less
- Hysteresis: 0.5% F.S. or less
- Cable connections in 2 directions

Straight type

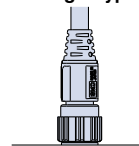

Right angle type

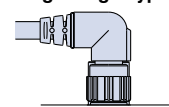

Modular connection is possible.

* Products should be ordered separately and assembled by the customer.



Gain setting

This product can change the response with this gain setting.

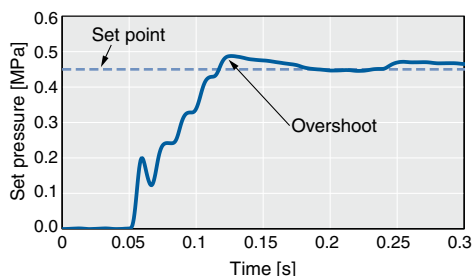

Change the gain.

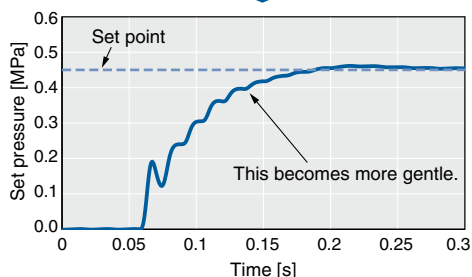

Sensitivity setting

When the sensitivity is adjusted, the correction operation of pressure changes.

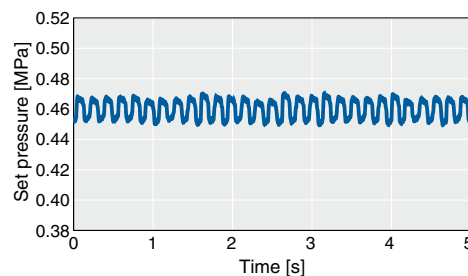

Change the sensitivity.

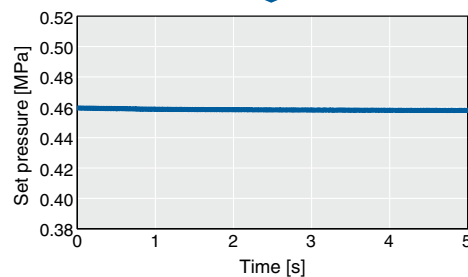

Download the Operation Manual that describes the setting method from the SMC website. This function is also installed in the existing products (ITV10□□/ITV20□□/ITV30□□).

More information can be viewed here.



Applications

Tension Control

Printing machines / Film and cardboard processing machines

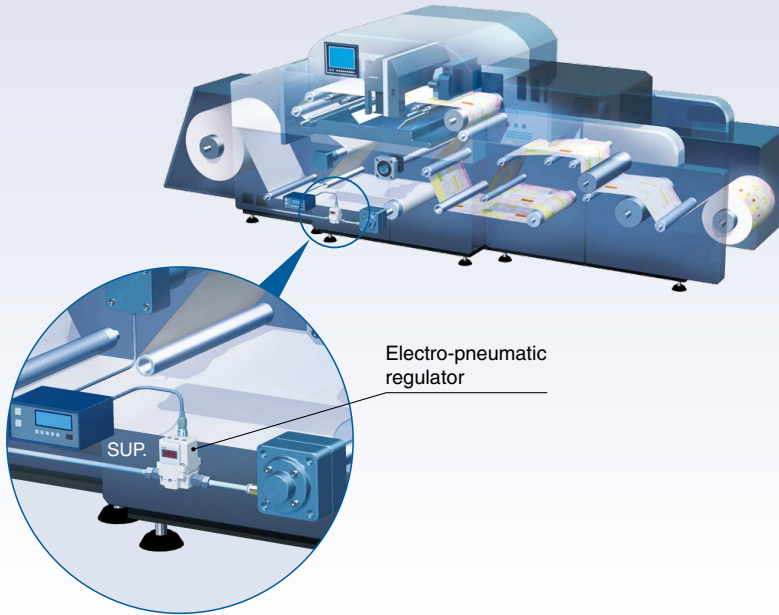

Coil winding machines

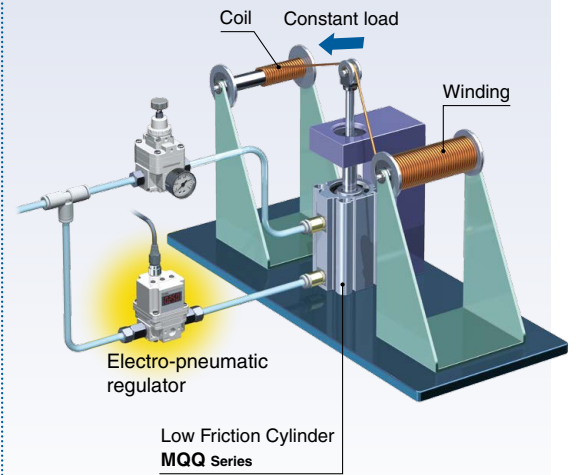

Actuator Thrust Control

Whetstone polishing

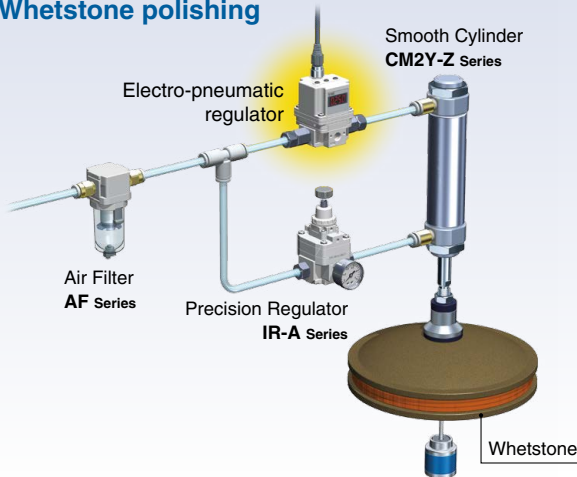

Wavy surface cutting

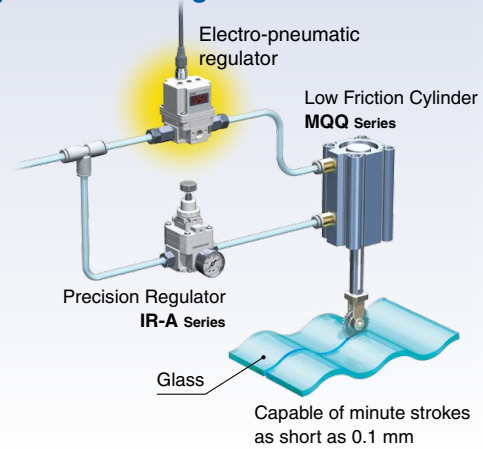

Flow Rate Control

By fixing the nozzle orifice, pressure control can be used to control the flow rate.

Cleaning machines

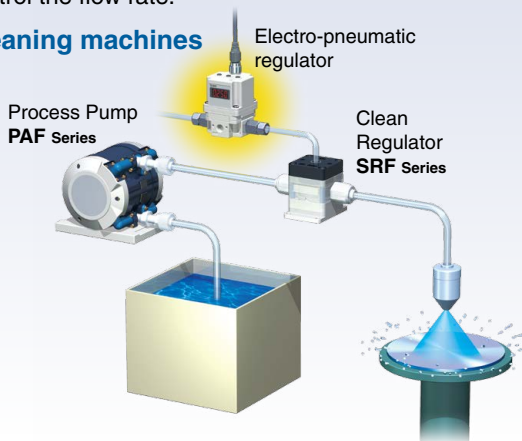

Pressure Filling



Leak tester



Electro-Pneumatic Regulator / High Flow Rate *ITV1100/2100/3100 Series*

Series Variations

For the stepless control of air pressure in proportion to electrical signals

Series	Model	Set pressure range	Input signal	Port size		
ITV1100 Series 	ITV111 □	0.005 to 0.1 MPa	Current type 4 to 20 mA DC (Sink type) Current type 0 to 20 mA DC (Sink type) Voltage type 0 to 5 VDC Voltage type 0 to 10 VDC	1/8, 1/4		
	ITV113 □	0.005 to 0.5 MPa				
	ITV115 □	0.005 to 0.9 MPa				
ITV2100 Series 	ITV211 □	0.005 to 0.1 MPa		Current type 4 to 20 mA DC (Sink type) Current type 0 to 20 mA DC (Sink type) Voltage type 0 to 5 VDC Voltage type 0 to 10 VDC	1/4, 3/8	
	ITV213 □	0.005 to 0.5 MPa				
	ITV215 □	0.005 to 0.9 MPa				
ITV3100 Series 	ITV311 □	0.005 to 0.1 MPa			Current type 4 to 20 mA DC (Sink type) Current type 0 to 20 mA DC (Sink type) Voltage type 0 to 5 VDC Voltage type 0 to 10 VDC	1/4, 3/8, 1/2
	ITV313 □	0.005 to 0.5 MPa				
	ITV315 □	0.005 to 0.9 MPa				

CONTENTS

Electro-Pneumatic Regulator / High Flow Rate *ITV1100/2100/3100 Series*

How to Order	p. 4	ITV113□ Series	p. 10
Standard Specifications	p. 5	ITV213□ Series	p. 11
Modular Products and Accessories	p. 6	ITV313□ Series	p. 12
Linearity, Hysteresis, Repeatability, Pressure Characteristics, Relief Characteristics, Flow Rate Characteristics, Response Characteristics		ITV115□ Series	p. 13
ITV111□ Series	p. 7	ITV215□ Series	p. 14
ITV211□ Series	p. 8	ITV315□ Series	p. 15
ITV311□ Series	p. 9	Construction	p. 16
		Dimensions	p. 18
		Specific Product Precautions	p. 21

Electro-Pneumatic Regulator / High Flow Rate

ITV1100/2100/3100 Series



How to Order

ITV **3** **1** **1** **0** - **0** **1** **2** **S**

Model

1	1100 type
2	2100 type
3	3100 type

Pressure range

1	0.1 MPa
3	0.5 MPa
5	0.9 MPa

Power supply voltage

0	24 VDC
1	12 to 15 VDC

Pressure display unit

Nil	MPa
2*2	kgf/cm ²
3	bar
4*2	psi
5	kPa

*2 This product is for overseas use only according to the New Measurement Act. (The SI unit type is provided for use in Japan.)

Cable connector type

S	Straight type 3 m
L	Right angle type 3 m
N	Without cable connector

Input signal

0	Current type 4 to 20 mADC (Sink type)
1	Current type 0 to 20 mADC (Sink type)
2	Voltage type 0 to 5 VDC
3	Voltage type 0 to 10 VDC
40	4 points preset input

Monitor output

1	Analog output 1 to 5 VDC
2	Switch output/NPN output
3	Switch output/PNP output
4	Analog output 4 to 20 mADC (Sink type)
Nil	None

Bracket*1

Nil	Without bracket
B	Flat bracket
C	L-bracket

*1 The bracket is included.

Thread type

Nil	Rc
N	NPT
F	G

Port size

		1100	2100	3100
Nil	1/8	●	—	—
2	1/4	●	●	●
3	3/8	—	●	●
4	1/2	—	—	●

ITV1100/2100/3100 Series



Symbol

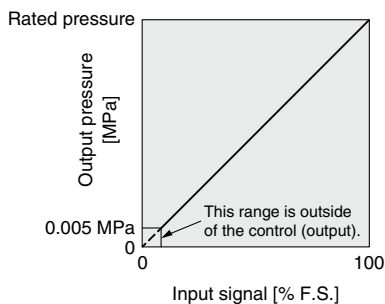
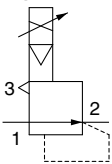

Fig. 1 Input/output characteristics chart

Table 1 Set pressure range by unit of standard measured pressure

Unit	Set pressure range		
	ITV□11□	ITV□13□	ITV□15□
MPa	0.005 to 0.1	0.005 to 0.5	0.005 to 0.9
kgf/cm ²	0.05 to 1	0.05 to 5	0.05 to 9
bar	0.05 to 1	0.05 to 5	0.05 to 9
psi	0.7 to 15	0.7 to 70	0.7 to 130
kPa	5 to 100	5 to 500	5 to 900

Standard Specifications*1

Model	ITV111□*7	ITV113□*7	ITV115□*7
	ITV211□	ITV213□	ITV215□
	ITV311□	ITV313□	ITV315□
Fluid	Air		
Min. supply pressure	Set pressure + 0.05 MPa		
Max. supply pressure	0.2 MPa	1.0 MPa	
Set pressure range (Rated)*2	0.005 to 0.1 MPa	0.005 to 0.5 MPa	0.005 to 0.9 MPa
Power supply	Voltage/Current consumption	24 VDC ±10% (Stabilized power supply with a ripple rate of 1% or less) /0.12 A or less	
		12 to 15 VDC (Stabilized power supply with a ripple rate of 1% or less) /0.18 A or less	
Input signal	Current type*3	4 to 20 mA DC, 0 to 20 mA DC (Sink type)	
	Voltage type	0 to 5 VDC, 0 to 10 VDC	
	Preset input	4 points (Negative common)	
Input impedance	Current type	350 Ω or less (Including over current circuit)	
	Voltage type	Approx. 6.5 kΩ	
	Preset input	Power supply voltage 24 VDC type: Approx. 4.7 kΩ Power supply voltage 12 VDC type: Approx. 2.0 kΩ	
Output signal*4 (Monitor output)	Analog output	1 to 5 VDC (Output impedance: Approx. 1 kΩ) 4 to 20 mA DC (Output impedance: 250 Ω or less) Output accuracy: ±6% F.S. or less	
	Switch output	NPN open collector output: Max. 30 V, 80 mA PNP open collector output: Max. 80 mA	
Linearity*5	±1% F.S. or less		
Hysteresis*5	0.5% F.S. or less		
Repeatability*5	±0.5% F.S. or less		
Sensitivity (Input signal resolution)	±0.2% F.S. or less		
Temperature characteristics	±0.12% F.S./°C or less		
Output pressure display*6	Display type	3-digit, 7-segment LED, 1-color display (Red)	
	Accuracy	±2% F.S. ±1 digit or less	
	Min. unit	MPa: 0.001 (Actual display: .001), kgf/cm ² : 0.01, bar: 0.01, psi: 0.1, kPa: 1	
Ambient and fluid temperatures	0 to 50°C (No condensation)		
Enclosure	IP65		
Weight	ITV11□□	Approx. 235 g (Without accessories)	
	ITV21□□	Approx. 285 g (Without accessories)	
	ITV31□□	Approx. 555 g (Without accessories)	

*1 This specification table shows the characteristics at a power supply voltage of 24 VDC, ambient temperature of 25 ±3°C, and no load applied.

Only in static conditions, the pressure may fluctuate when air is consumed on the output side.

*2 Refer to Fig. 1 for the relationship between set pressure and input.

Because the max. set pressure differs for each pressure display, refer to Table 1 to the left.

When the input signal is 0%, there is residual pressure equal to or less than the minimum set pressure (0.005 MPa).

In cases where the pressure needs to be reduced completely to 0, install a 3-port valve, etc., on the output side to discharge the residual pressure.

*3 2-wire type 4 to 20 mA DC is not available. Power supply voltage (24 VDC or 12 to 15 VDC) is required.

*4 Select either analog output or switch output for the output signal.

Further, when switch output is selected, select either NPN output or PNP output.

The 4-point preset type is not equipped with an output signal.

When measuring analog output from 1 to 5 VDC, if the load impedance is less than 100 kΩ, the analog output accuracy of ±6% F.S. or less may not be available.

*5 Compliant with ISO 10094

*6 The zero/span adjustment values and the preset pressure settings are set from the minimum unit of the output pressure display.

Note that the unit cannot be changed.

The min. unit for 0.9 MPa (130 psi) types is 1 psi.

For safety reasons, it is recommended that one of the preset pressures be set to 0 MPa.

*7 The ITV1100 series has parts in contact with fluid with non-grease specification.

Modular Products and Accessory Combinations

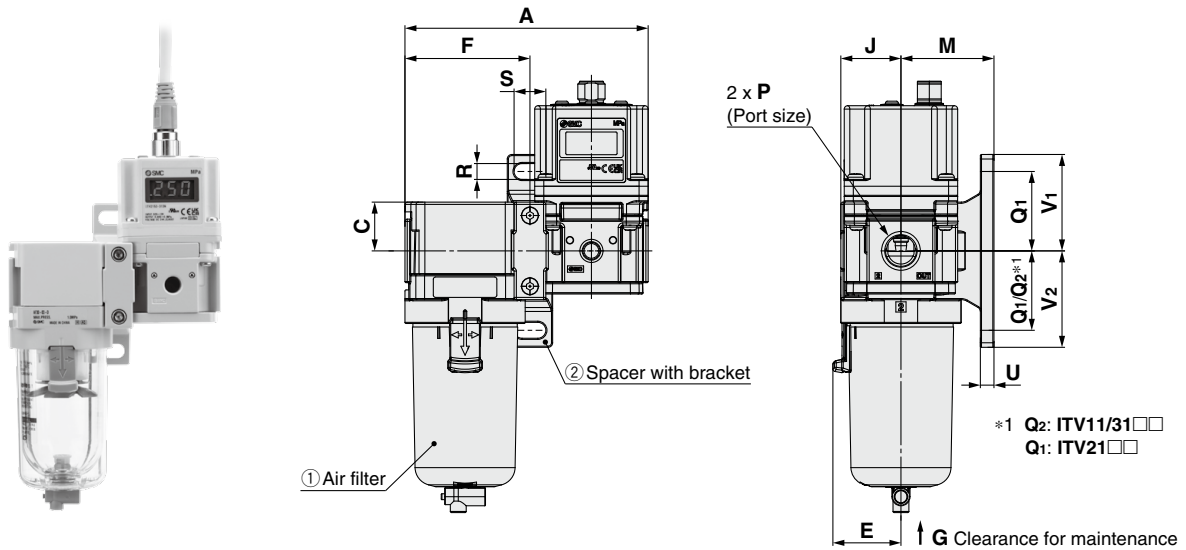

Model	Applicable products and accessories			Standard specifications								Optional specifications						
	① Air filter	② Spacer with bracket	③ Spacer	P	A	C	E	F	G	J	Bracket mount							
											M	Q1	Q2	R	S	U	V1	V2
ITV11□□	AF20-□□-D	Y200T-D	Y200-D	1/8, 1/4	93.2	17.5	—	41.6	25	25	30	24	33	5.5	11.5	3.5	29	38
ITV21□□	AF30-□□-D	Y300T-D	Y300-D	1/4, 3/8	107.2	21.5	30	55.1	35	26.5	41	35	—	7	14	6	42.5	42.5
ITV31□□	AF40-□□-D	Y400T-D	Y400-D	1/4, 3/8, 1/2	141.2	25.5	38.4	72.6	40	35.5	50	40	55	9	18	7	50	65

Accessories (Option)/Part Nos.

Bracket (Including mounting screws)

Accessories		Applicable model		
		ITV11□□	ITV21□□	ITV31□□
Flat bracket assembly	Part number	P398010-600	P398020-600	
	Screw size	M4 x 0.7 x 8	M5 x 0.8 x 10	
	Bracket tightening torque	0.76 ±0.05 N·m	1.5 ±0.05 N·m	
L-bracket assembly	Part number	P398010-601	P398020-601	
	Screw size	M4 x 0.7 x 8	M5 x 0.8 x 10	
	Bracket tightening torque	0.76 ±0.05 N·m	1.5 ±0.05 N·m	

Cable Connector

Model	Type	Recommended cable part no.
ITV□1□□-□□	Straight 3 m	P398020-500-3
	Right angle 3 m	P398020-501-3

Recommended power supply cable length is 3 m. If any other length is desired, please contact SMC.

[Cable Connector Specifications]

P398020-500-3, P398020-501-3

Conductor	Nominal cross section	4 x AWG21
	Outside diameter	Approx. 0.9 mm
Insulator	Outside diameter	Approx. 1.7 mm
Sheath	Material	PVC
Finished outside diameter		ø6 mm
Min. bending radius		60 mm

ITV1100/2100/3100 Series

ITV111□ Series

Compliant with ISO 10094

Linearity

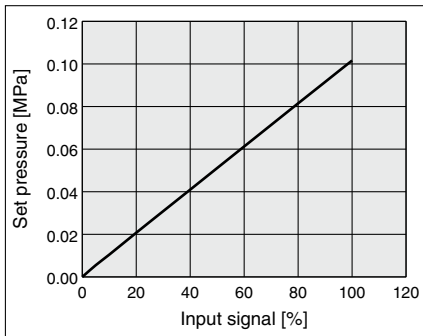

Hysteresis

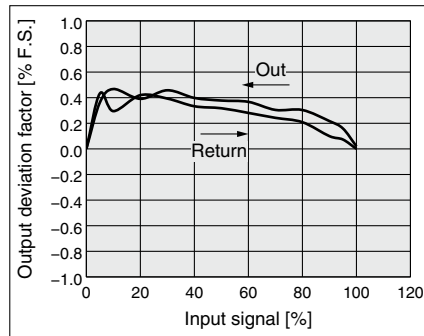

Repeatability

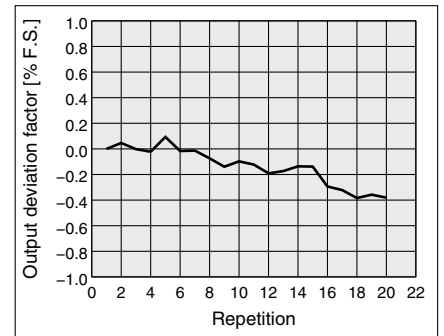

Pressure Characteristics Set pressure: 0.04 MPa

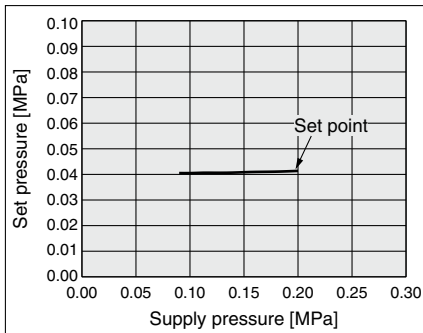

Relief Characteristics Back pressure: 0.2 MPa

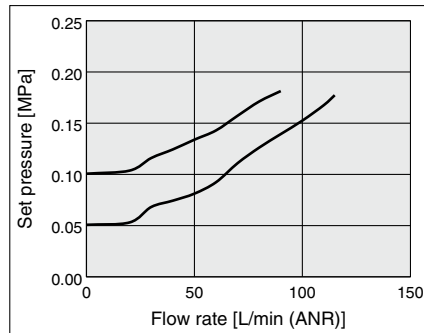

Excessive back pressure may damage the product.
For an application that requires exhaust flow rate control, use the ITV201□ series (larger size).

Flow Rate Characteristics ITV111□-□□□1□□□ (Port size: 1/8)

Supply pressure: 0.2 MPa

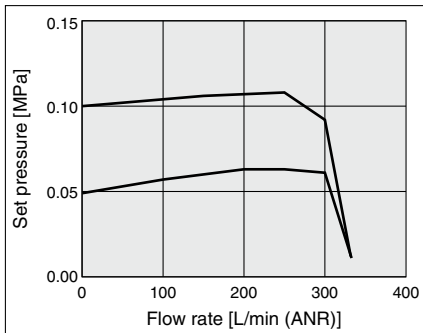

Flow Rate Characteristics ITV111□-□□□2□□□ (Port size: 1/4)

Supply pressure: 0.2 MPa

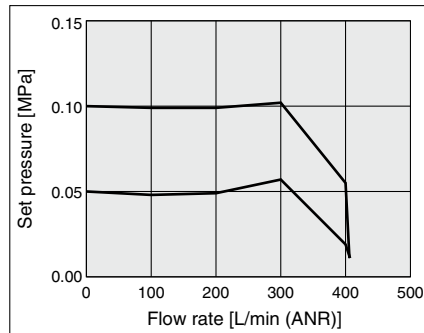

Response Characteristics (0 → 0.1 MPa/0 → 100%)

Supply pressure: 0.2 MPa

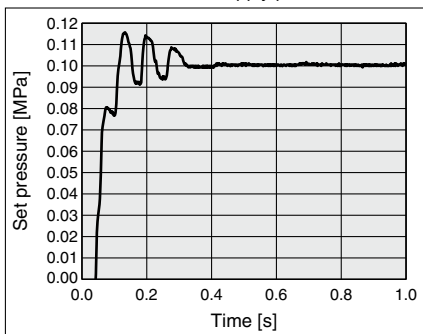

Power supply voltage: 24 VDC, Ambient temperature: 25 ±3°C, With no load on the outlet side

Response Characteristics (0.025 → 0.075 MPa/25 → 75%)

Supply pressure: 0.2 MPa

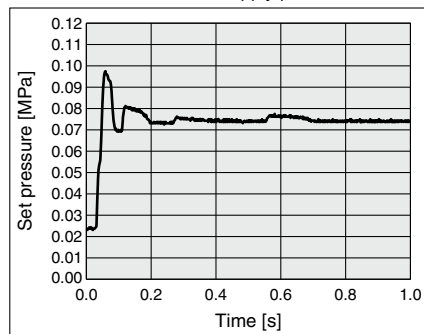

Power supply voltage: 24 VDC, Ambient temperature: 25 ±3°C, With no load on the outlet side

Response Characteristics (0.045 → 0.055 MPa/45 → 55%)

Supply pressure: 0.2 MPa

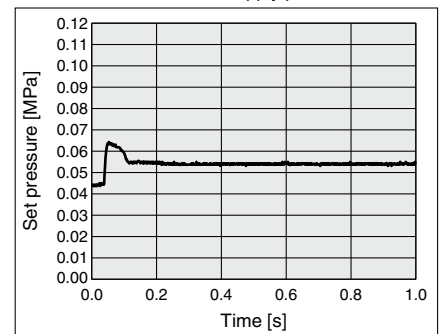

Power supply voltage: 24 VDC, Ambient temperature: 25 ±3°C, With no load on the outlet side

⚠ Caution

For an application that requires exhaust flow rate control, use the ITV201□ series (larger size).

ITV211□ Series

Compliant with ISO 10094

Linearity

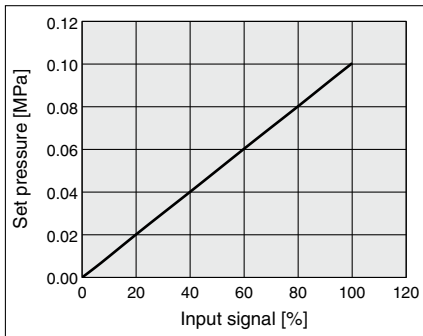

Hysteresis

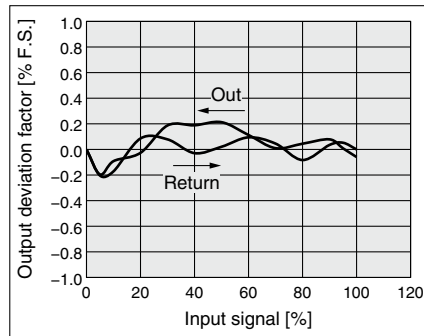

Repeatability

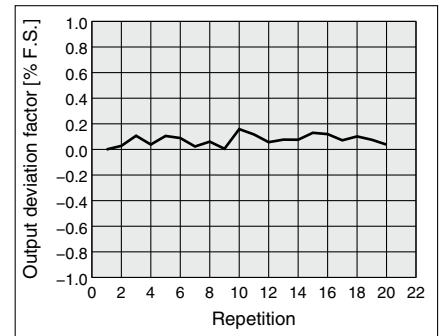

Pressure Characteristics Set pressure: 0.04 MPa

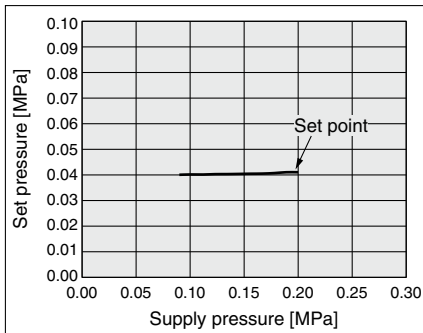

Relief Characteristics Back pressure: 0.2 MPa

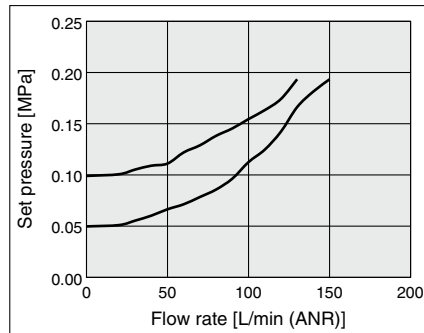

Reference: ITV201□ Relief Characteristics Back pressure: 0.2 MPa

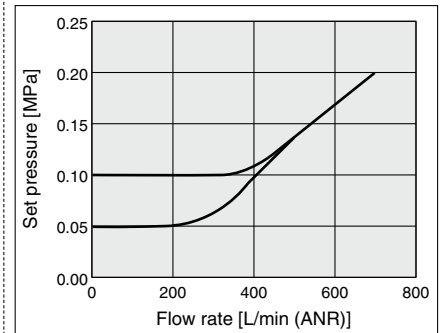

Excessive back pressure may damage the product.
Use the ITV201□ series for applications that require a higher flow rate.

Flow Rate Characteristics ITV211□-□□□2□□□ (Port size: 1/4) Supply pressure: 0.2 MPa

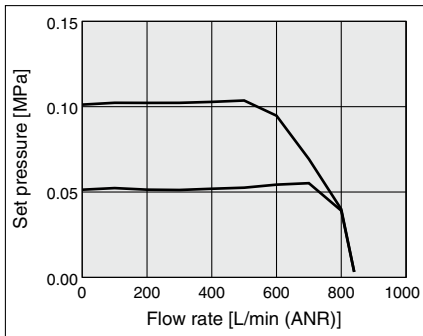

Flow Rate Characteristics ITV211□-□□□3□□□ (Port size: 3/8) Supply pressure: 0.2 MPa

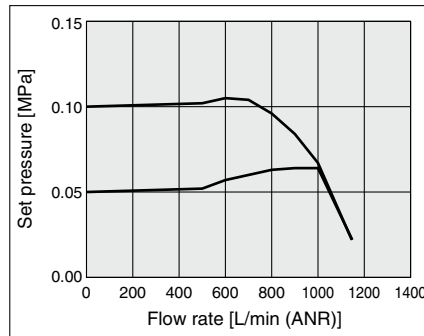

Response Characteristics (0 → 0.1 MPa/0 → 100%) Supply pressure: 0.2 MPa

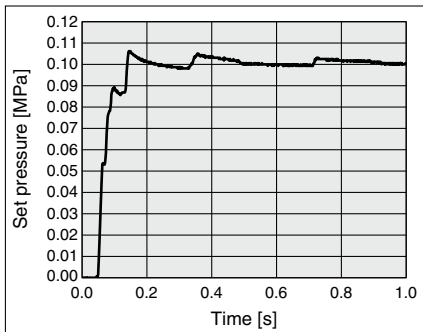

Response Characteristics (0.025 → 0.075 MPa/25 → 75%) Supply pressure: 0.2 MPa

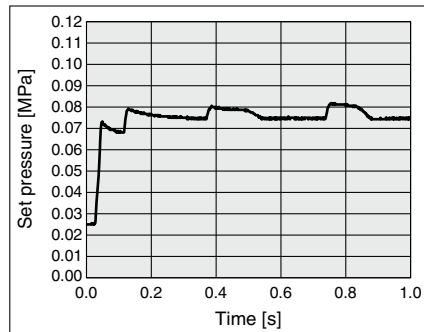

Response Characteristics (0.045 → 0.055 MPa/45 → 55%) Supply pressure: 0.2 MPa

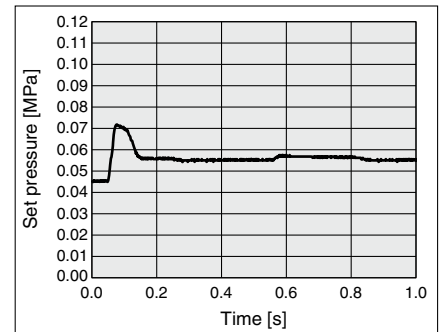

Power supply voltage: 24 VDC, Ambient temperature: 25 ±3°C, With no load on the outlet side

Power supply voltage: 24 VDC, Ambient temperature: 25 ±3°C, With no load on the outlet side

Power supply voltage: 24 VDC, Ambient temperature: 25 ±3°C, With no load on the outlet side

⚠ Caution

Use the ITV201□ series for applications that require a higher flow rate.

ITV1100/2100/3100 Series

ITV311□ Series

Compliant with ISO 10094

Linearity

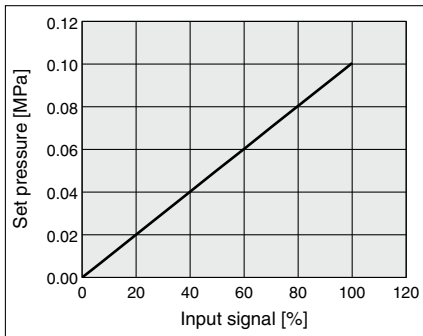

Hysteresis

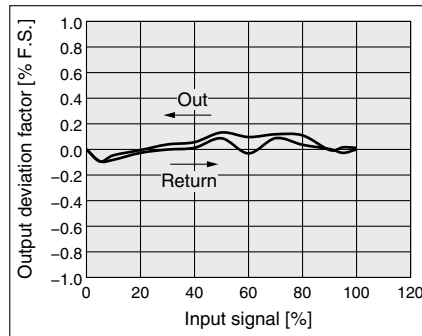

Repeatability

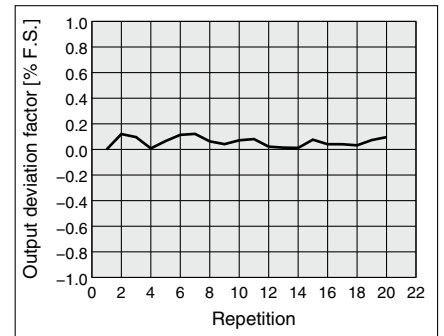

Pressure Characteristics Set pressure: 0.04 MPa

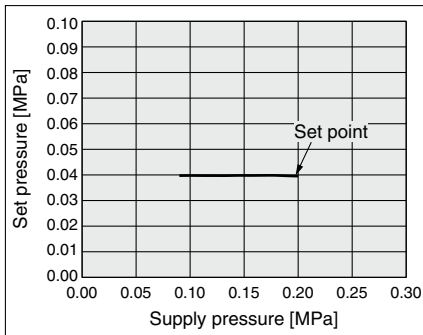

Relief Characteristics Back pressure: 0.2 MPa

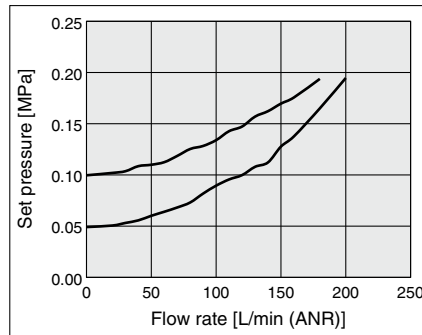

Reference: ITV301□

Relief Characteristics Back pressure: 0.2 MPa

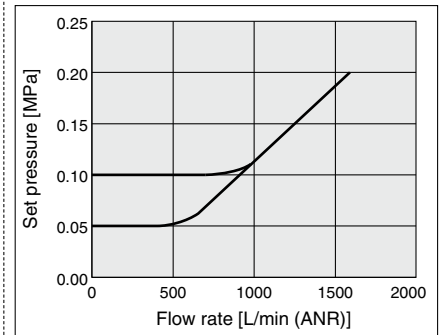

Excessive back pressure may damage the product. Use the ITV301□ series for applications that require a higher flow rate.

Flow Rate Characteristics ITV311□-□□□2□□□ (Port size: 1/4) Supply pressure: 0.2 MPa

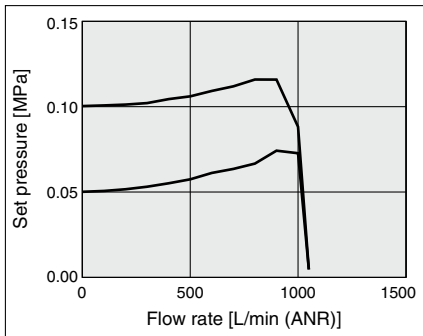

Flow Rate Characteristics ITV311□-□□□3□□□ (Port size: 3/8) Supply pressure: 0.2 MPa

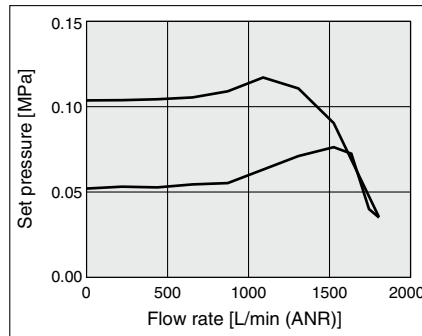

Flow Rate Characteristics ITV311□-□□□4□□□ (Port size: 1/2) Supply pressure: 0.2 MPa

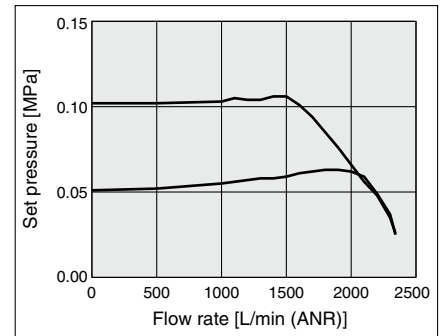

Response Characteristics (0 → 0.1 MPa/0 → 100%) Supply pressure: 0.2 MPa

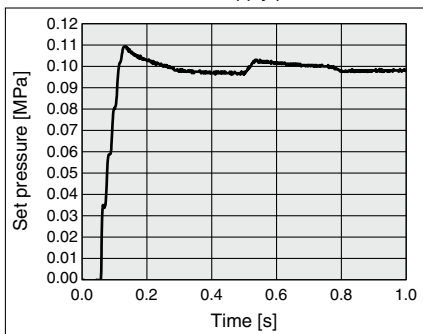

Response Characteristics (0.025 → 0.075 MPa/25 → 75%) Supply pressure: 0.2 MPa

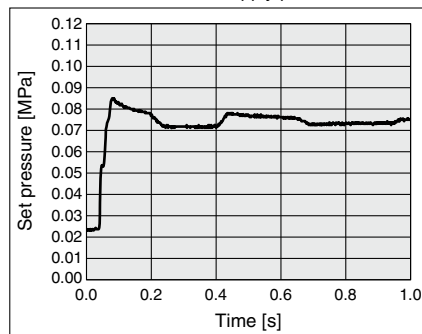

Response Characteristics (0.045 → 0.055 MPa/45 → 55%) Supply pressure: 0.2 MPa

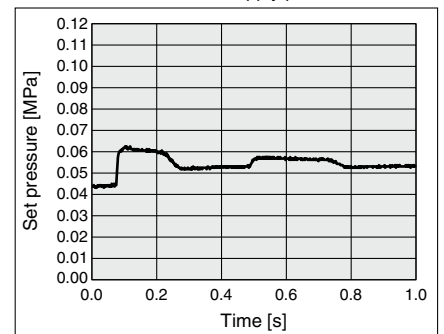

Power supply voltage: 24 VDC, Ambient temperature: 25 ±3°C, With no load on the outlet side

Power supply voltage: 24 VDC, Ambient temperature: 25 ±3°C, With no load on the outlet side

Power supply voltage: 24 VDC, Ambient temperature: 25 ±3°C, With no load on the outlet side

Caution

Use the ITV301□ series for applications that require a higher flow rate.

ITV113 Series

Compliant with ISO 10094

Linearity

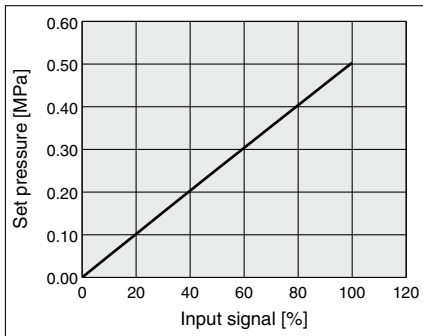

Hysteresis

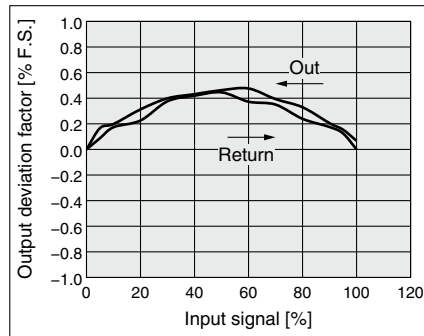

Repeatability

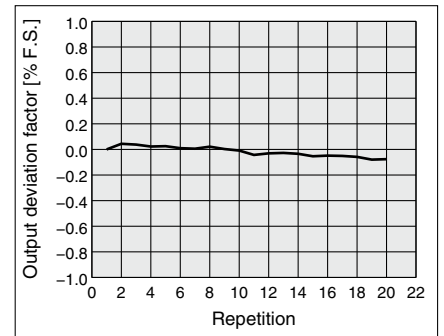

Pressure Characteristics Set pressure: 0.2 MPa

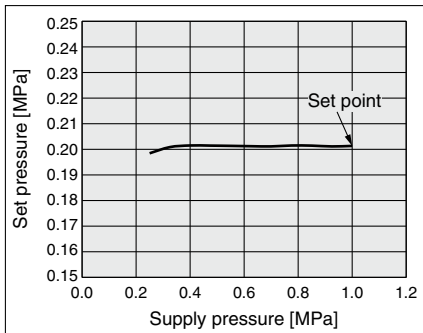

Relief Characteristics Back pressure: 0.7 MPa

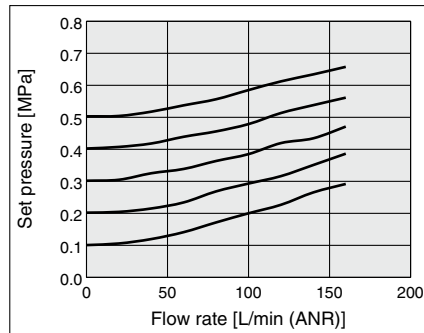

Excessive back pressure may damage the product.
For an application that requires exhaust flow rate control, use the ITV203 series (larger size).

Flow Rate Characteristics ITV113-□□□□□□□□ (Port size: 1/8)

Supply pressure: 0.7 MPa

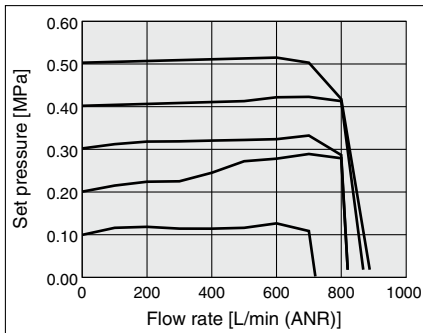

Flow Rate Characteristics ITV113-□□□□□□□□ (Port size: 1/4)

Supply pressure: 0.7 MPa

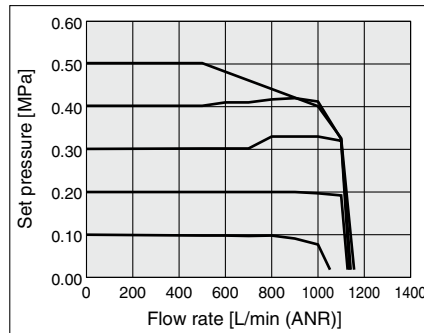

Response Characteristics (0 → 0.5 MPa/0 → 100%)

Supply pressure: 0.7 MPa

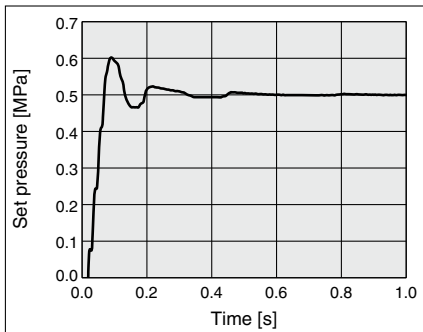

Power supply voltage: 24 VDC, Ambient temperature: 25 ±3°C, With no load on the outlet side

Response Characteristics (0.125 → 0.375 MPa/25 → 75%)

Supply pressure: 0.7 MPa

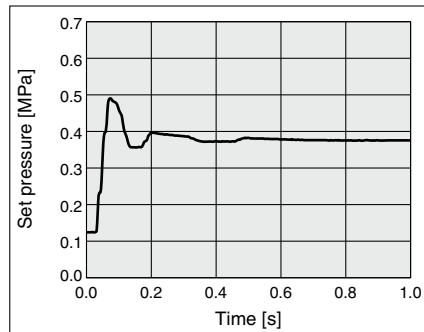

Power supply voltage: 24 VDC, Ambient temperature: 25 ±3°C, With no load on the outlet side

Response Characteristics (0.225 → 0.275 MPa/45 → 55%)

Supply pressure: 0.7 MPa

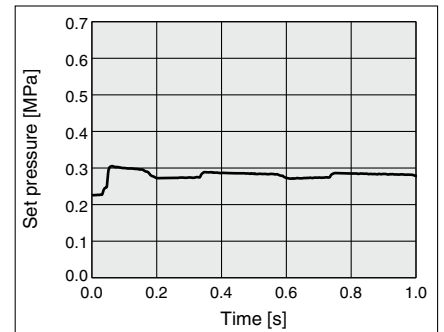

Power supply voltage: 24 VDC, Ambient temperature: 25 ±3°C, With no load on the outlet side

⚠ Caution

For an application that requires exhaust flow rate control, use the ITV203 series (larger size).

ITV1100/2100/3100 Series

ITV213 Series

Compliant with ISO 10094

Linearity

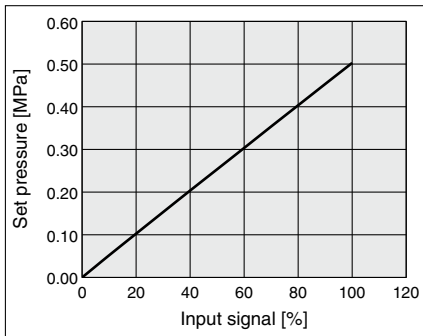

Hysteresis

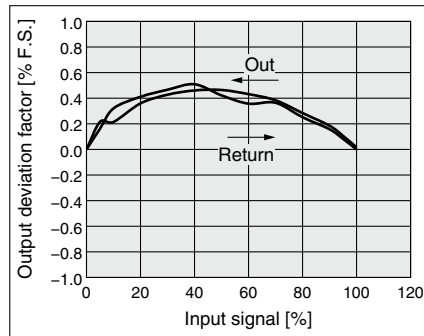

Repeatability

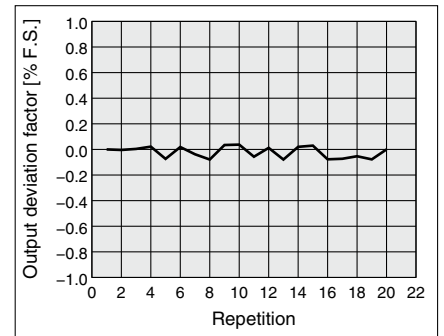

Pressure Characteristics Set pressure: 0.2 MPa

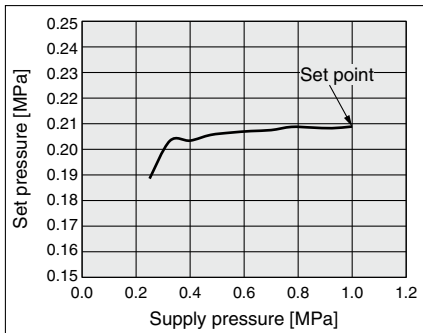

Relief Characteristics Back pressure: 0.7 MPa

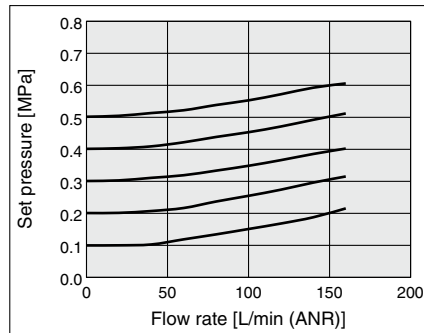

Reference: ITV203 Relief Characteristics Back pressure: 0.7 MPa

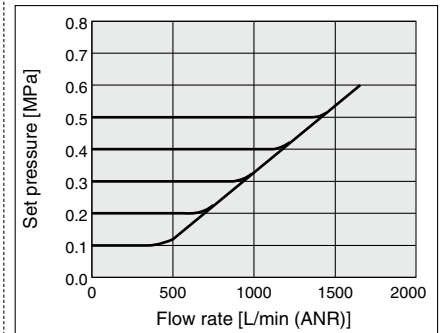

Excessive back pressure may damage the product.
Use the ITV203 series for applications that require a higher flow rate.

Flow Rate Characteristics ITV213-□□□2□□□ (Port size: 1/4) Supply pressure: 0.7 MPa

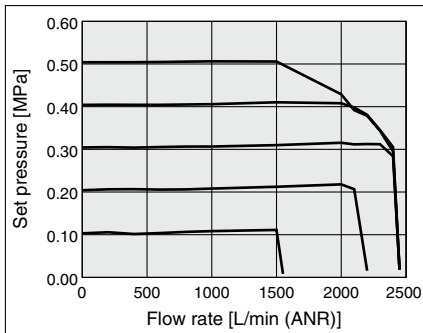

Flow Rate Characteristics ITV213-□□□3□□□ (Port size: 3/8) Supply pressure: 0.7 MPa

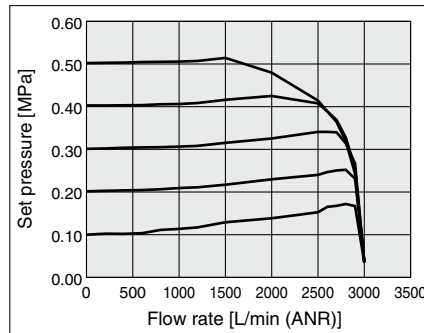

Response Characteristics (0 → 0.5 MPa/0 → 100%) Supply pressure: 0.7 MPa

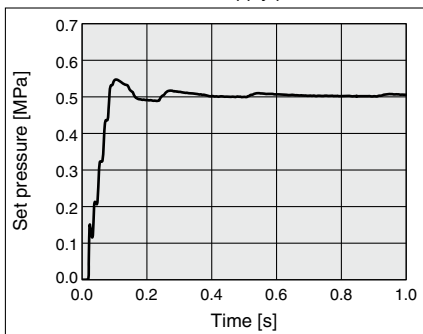

Response Characteristics (0.125 → 0.375 MPa/25 → 75%) Supply pressure: 0.7 MPa

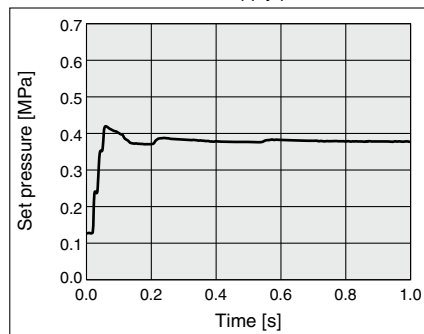

Response Characteristics (0.225 → 0.275 MPa/45 → 55%) Supply pressure: 0.7 MPa

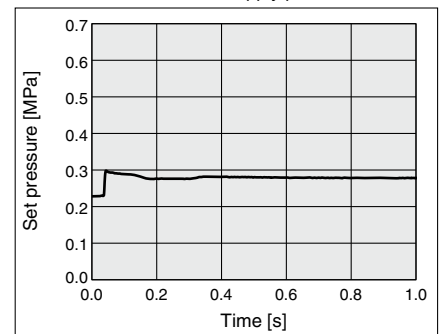

Power supply voltage: 24 VDC, Ambient temperature: 25 ±3°C, With no load on the outlet side

Power supply voltage: 24 VDC, Ambient temperature: 25 ±3°C, With no load on the outlet side

Power supply voltage: 24 VDC, Ambient temperature: 25 ±3°C, With no load on the outlet side

⚠ Caution

Use the ITV203 series for applications that require a higher flow rate.

ITV313□ Series

Compliant with ISO 10094

Linearity

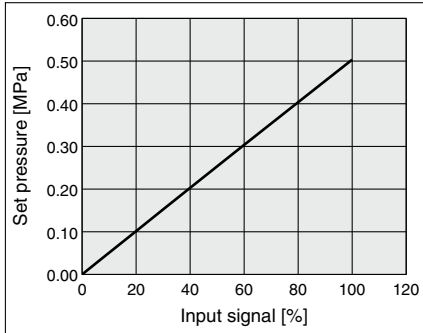

Hysteresis

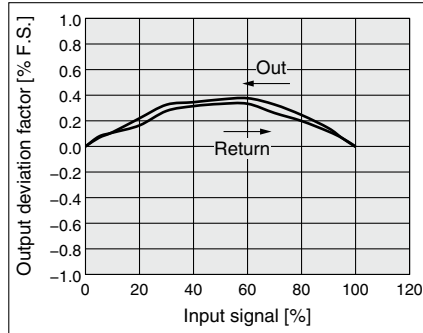

Repeatability

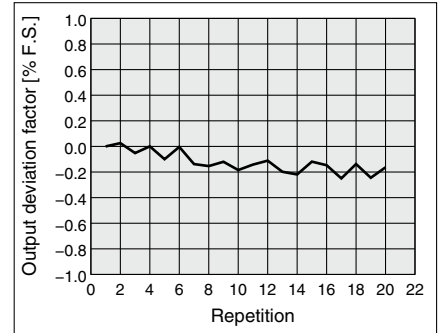

Pressure Characteristics Set pressure: 0.2 MPa

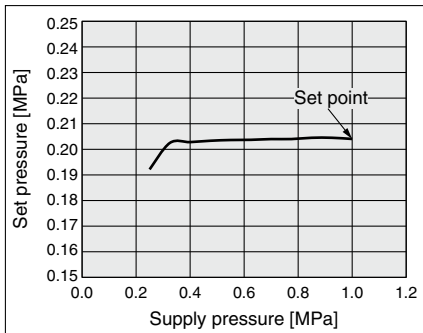

Relief Characteristics Back pressure: 0.7 MPa

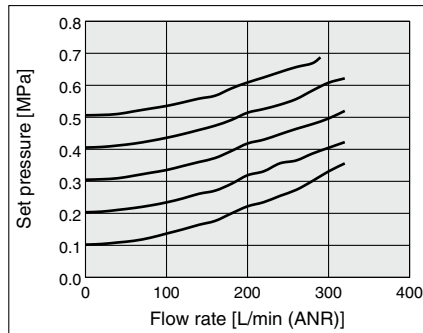

Reference: ITV303□

Relief Characteristics Back pressure: 0.7 MPa

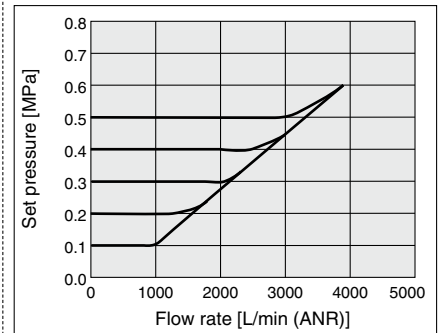

Excessive back pressure may damage the product.
Use the ITV303□ series for applications that require a higher flow rate.

Flow Rate Characteristics ITV313□-□□□2□□□ (Port size: 1/4)

Supply pressure: 0.7 MPa

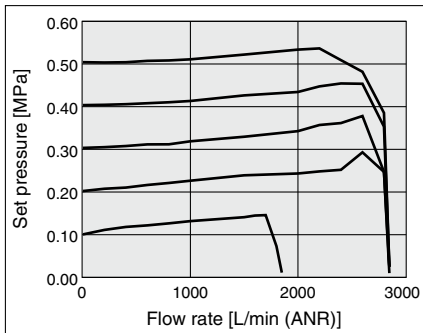

Flow Rate Characteristics ITV313□-□□□3□□□ (Port size: 3/8)

Supply pressure: 0.7 MPa

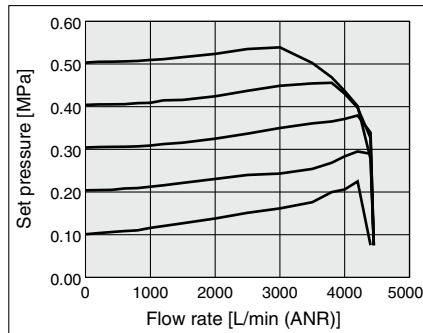

Flow Rate Characteristics ITV313□-□□□4□□□ (Port size: 1/2)

Supply pressure: 0.7 MPa

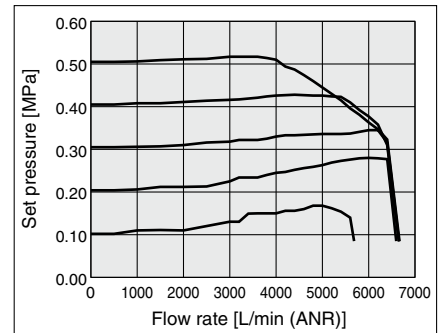

Response Characteristics (0 → 0.5 MPa/0 → 100%)

Supply pressure: 0.7 MPa

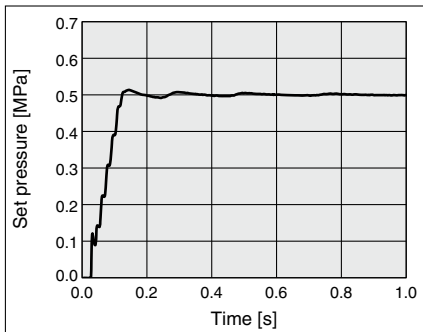

Response Characteristics (0.125 → 0.375 MPa/25 → 75%)

Supply pressure: 0.7 MPa

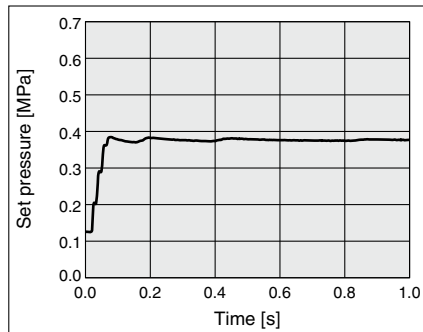

Response Characteristics (0.225 → 0.275 MPa/45 → 55%)

Supply pressure: 0.7 MPa

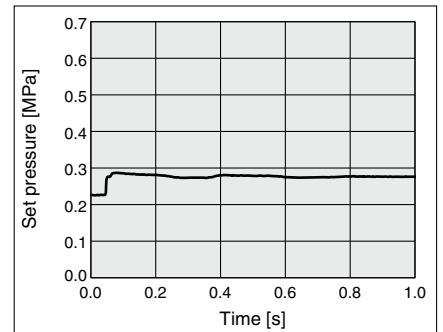

Power supply voltage: 24 VDC, Ambient temperature: 25 ±3°C, With no load on the outlet side

Power supply voltage: 24 VDC, Ambient temperature: 25 ±3°C, With no load on the outlet side

Power supply voltage: 24 VDC, Ambient temperature: 25 ±3°C, With no load on the outlet side

⚠ Caution

Use the ITV303□ series for applications that require a higher flow rate.

ITV1100/2100/3100 Series

ITV115□ Series

Compliant with ISO 10094

Linearity

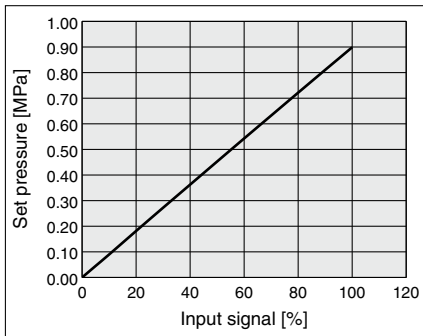

Hysteresis

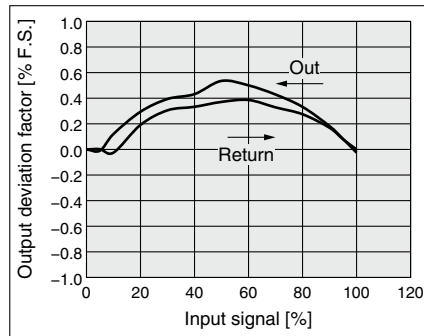

Repeatability

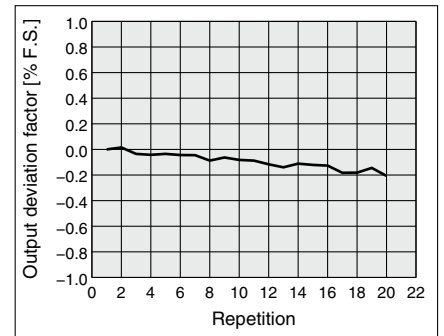

Pressure Characteristics Set pressure: 0.36 MPa

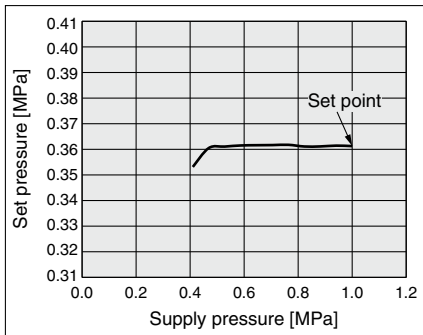

Relief Characteristics Back pressure: 1.0 MPa

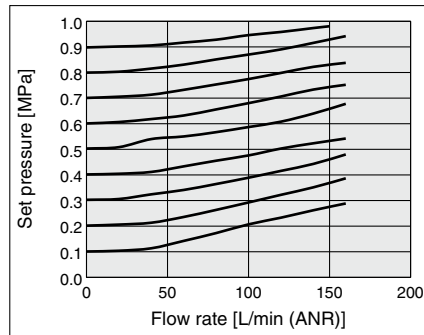

Flow Rate Characteristics ITV115□-□□□1□□□ (Port size: 1/8)

Supply pressure: 1.0 MPa

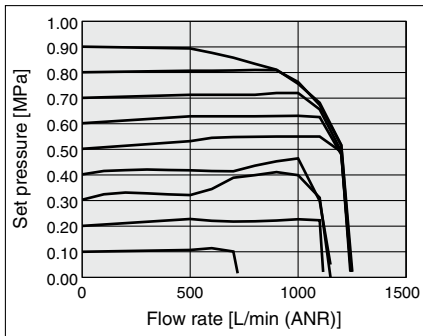

Flow Rate Characteristics ITV115□-□□□2□□□ (Port size: 1/4)

Supply pressure: 1.0 MPa

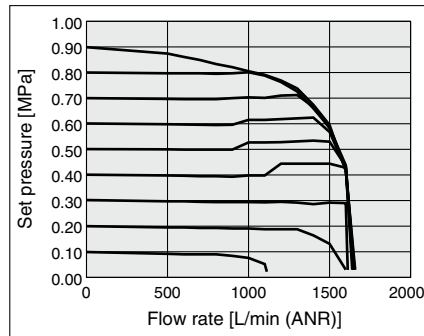

Response Characteristics (0 → 0.9 MPa/0 → 100%)

Supply pressure: 1.0 MPa

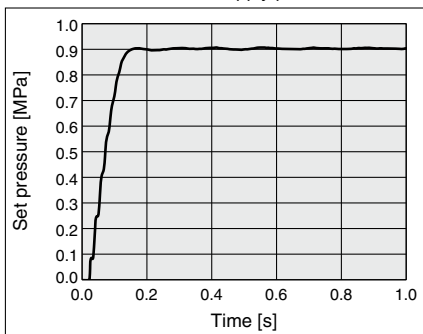

Response Characteristics (0.225 → 0.675 MPa/25 → 75%)

Supply pressure: 1.0 MPa

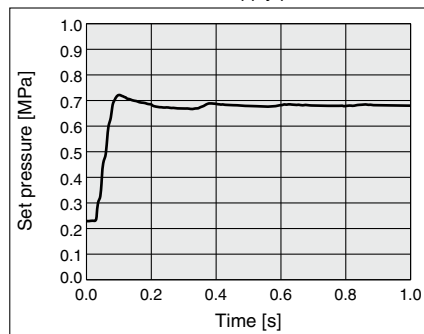

Response Characteristics (0.405 → 0.495 MPa/45 → 55%)

Supply pressure: 1.0 MPa

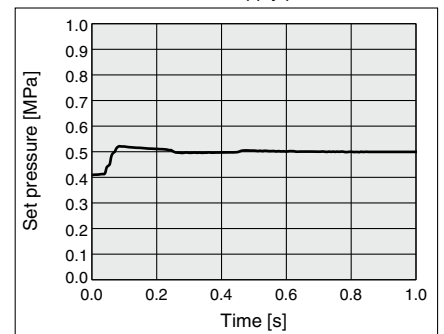

Power supply voltage: 24 VDC, Ambient temperature: 25 ±3°C, With no load on the outlet side

Power supply voltage: 24 VDC, Ambient temperature: 25 ±3°C, With no load on the outlet side

Power supply voltage: 24 VDC, Ambient temperature: 25 ±3°C, With no load on the outlet side

⚠ Caution

For an application that requires exhaust flow rate control, use the ITV205□ series (larger size).

ITV215□ Series

Compliant with ISO 10094

Linearity

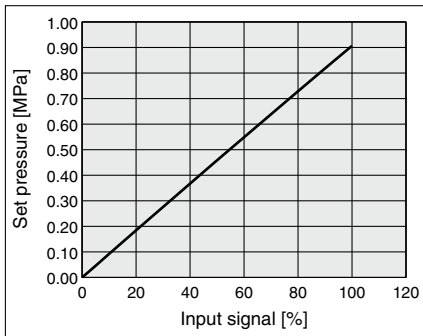

Hysteresis

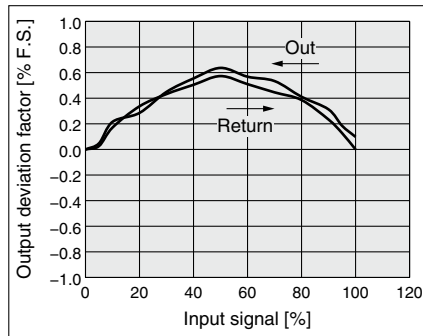

Repeatability

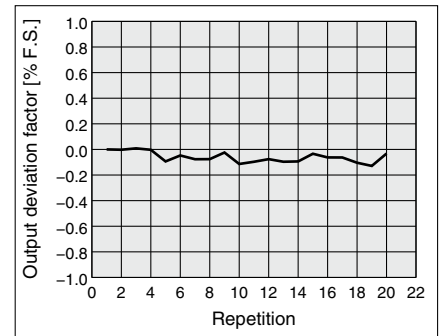

Pressure Characteristics Set pressure: 0.36 MPa

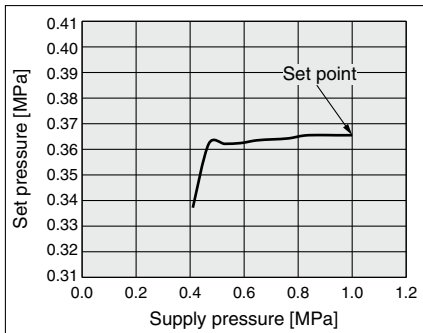

Relief Characteristics Back pressure: 1.0 MPa

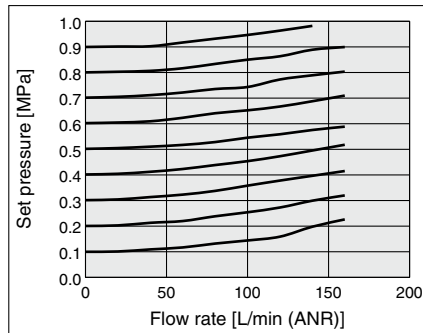

Reference: ITV205□

Relief Characteristics Back pressure: 1.0 MPa

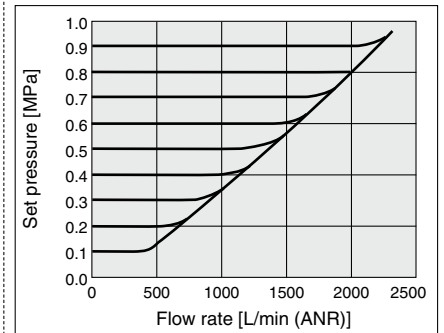

Excessive back pressure may damage the product.
Use the ITV205□ series for applications that require a higher flow rate.

Flow Rate Characteristics

ITV215□-□□□2□□□ (Port size: 1/4)

Supply pressure: 1.0 MPa

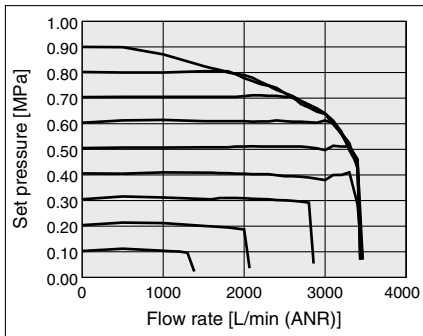

Flow Rate Characteristics

ITV215□-□□□3□□□ (Port size: 3/8)

Supply pressure: 1.0 MPa

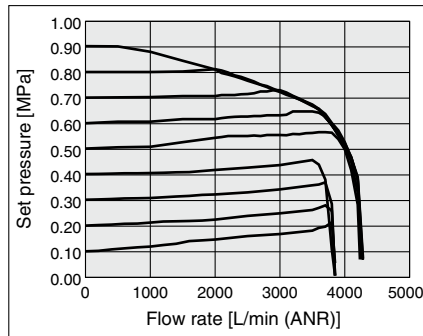

Response Characteristics

(0 → 0.9 MPa/0 → 100%)

Supply pressure: 1.0 MPa

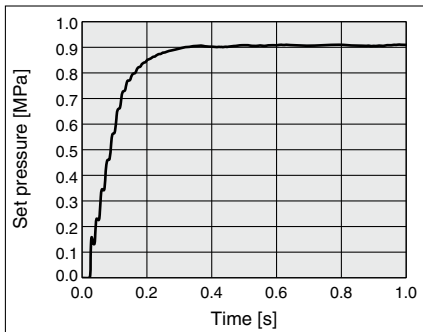

Response Characteristics

(0.225 → 0.675 MPa/25 → 75%)

Supply pressure: 1.0 MPa

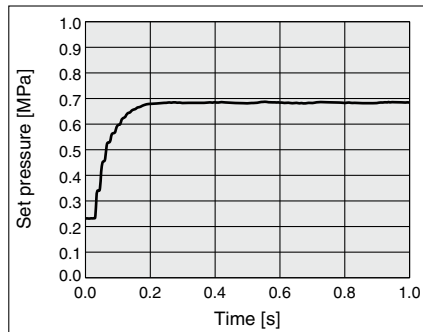

Response Characteristics

(0.405 → 0.495 MPa/45 → 55%)

Supply pressure: 1.0 MPa

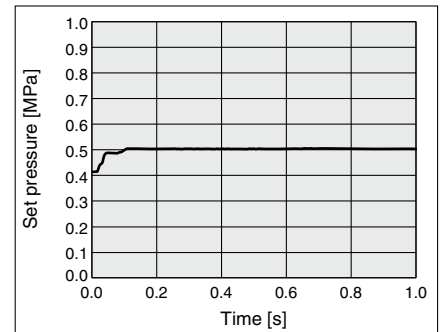

Power supply voltage: 24 VDC, Ambient temperature: 25 ±3°C, With no load on the outlet side

Power supply voltage: 24 VDC, Ambient temperature: 25 ±3°C, With no load on the outlet side

Power supply voltage: 24 VDC, Ambient temperature: 25 ±3°C, With no load on the outlet side

⚠ Caution

Use the ITV205□ series for applications that require a higher flow rate.

ITV1100/2100/3100 Series

ITV315 Series

Compliant with ISO 10094

Linearity

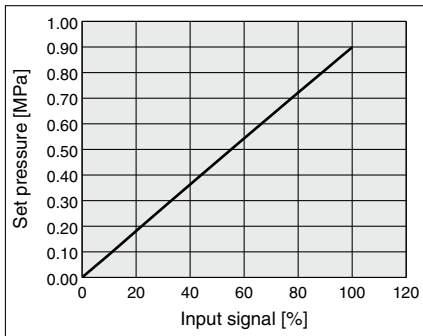

Hysteresis

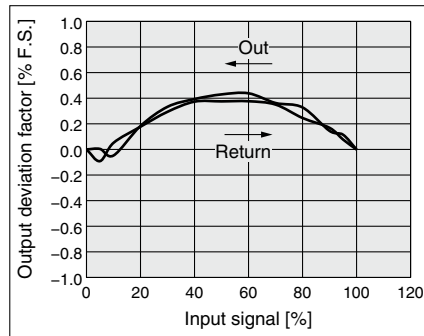

Repeatability

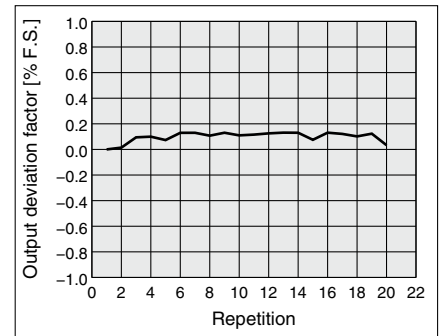

Pressure Characteristics Set pressure: 0.36 MPa

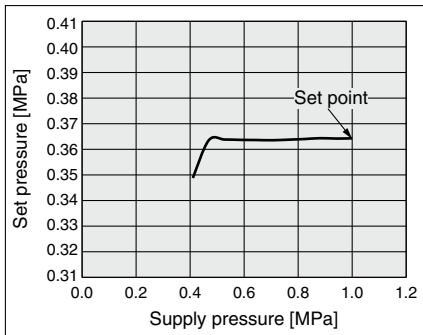

Relief Characteristics Back pressure: 1.0 MPa

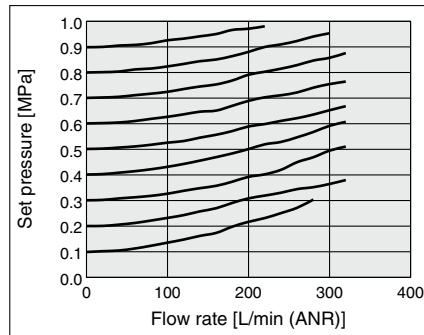

Reference: ITV305

Relief Characteristics Back pressure: 1.0 MPa

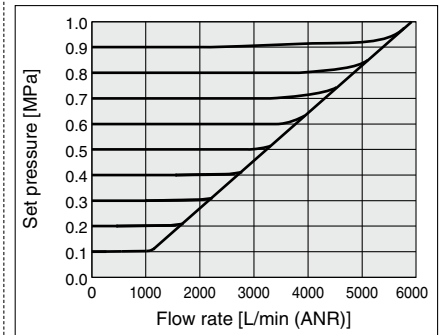

Excessive back pressure may damage the product.
Use the ITV305 series for applications that require a higher flow rate.

Flow Rate Characteristics ITV315-□□□2□□□ (Port size: 1/4)

Supply pressure: 1.0 MPa

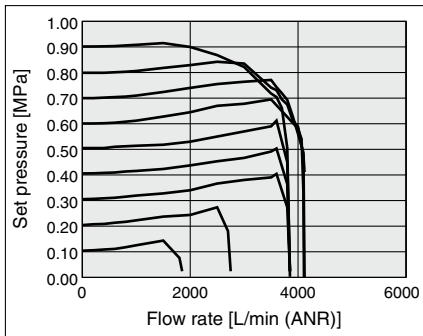

Flow Rate Characteristics ITV315-□□□3□□□ (Port size: 3/8)

Supply pressure: 1.0 MPa

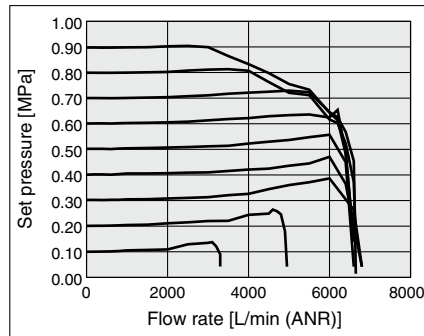

Flow Rate Characteristics ITV315-□□□4□□□ (Port size: 1/2)

Supply pressure: 1.0 MPa

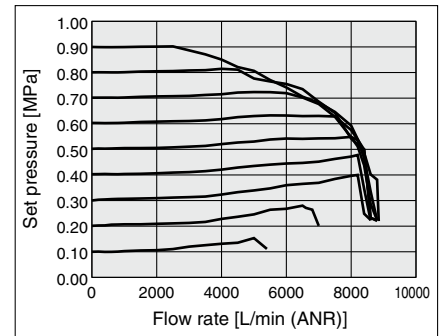

Response Characteristics (0 → 0.9 MPa/0 → 100%)

Supply pressure: 1.0 MPa

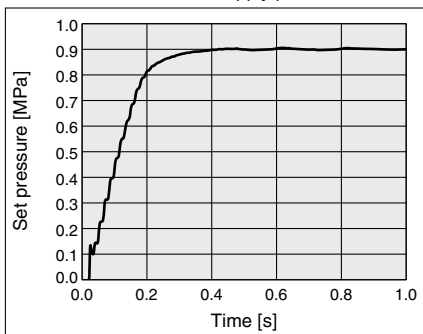

Response Characteristics (0.225 → 0.675 MPa/25 → 75%)

Supply pressure: 1.0 MPa

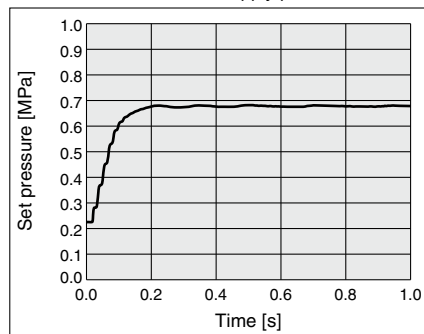

Response Characteristics (0.405 → 0.495 MPa/45 → 55%)

Supply pressure: 1.0 MPa

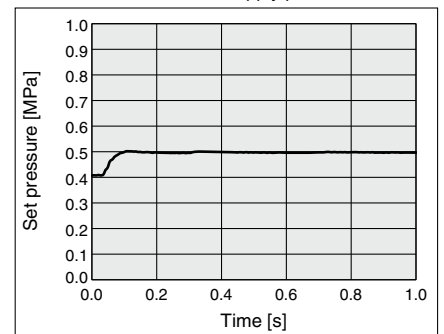

Power supply voltage: 24 VDC, Ambient temperature: 25 ±3°C, With no load on the outlet side

Power supply voltage: 24 VDC, Ambient temperature: 25 ±3°C, With no load on the outlet side

Power supply voltage: 24 VDC, Ambient temperature: 25 ±3°C, With no load on the outlet side

Caution

Use the ITV305 series for applications that require a higher flow rate.

Construction

ITV1100

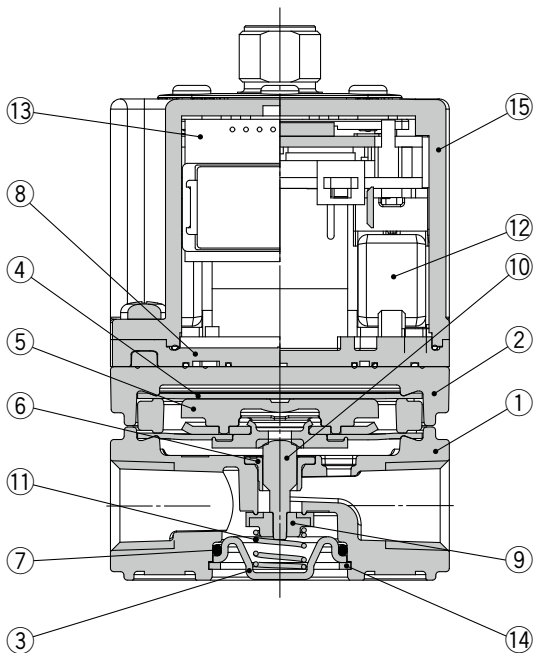

Main Component Parts

No.	Description	Material
◆ 1	Body	Aluminum alloy
2	Cover	Aluminum alloy
◆ 3	Valve guide	Stainless steel
◆ 4	Supply diaphragm	Rubber
◆ 5	Diaphragm assembly	Resin/Rubber/Stainless steel/ Brass/Carbon steel
◆ 6	Stem guide	Resin
◆ 7	Valve guide seal	HNBR
8	Sub-plate	Resin
◆ 9	Valve	Aluminum alloy/HNBR
◆ 10	Stem	Stainless steel
◆ 11	Valve spring	Stainless steel
12	Solenoid valve	—
13	Control circuit assembly	—
14	Type C retaining ring for hole	Stainless steel
15	Bowl cover assembly	Resin/Silicone rubber

* ◆ indicates parts in contact with the fluid.
In the control circuit assembly, only the built-in pressure sensor is the part in contact with the fluid.

ITV2100

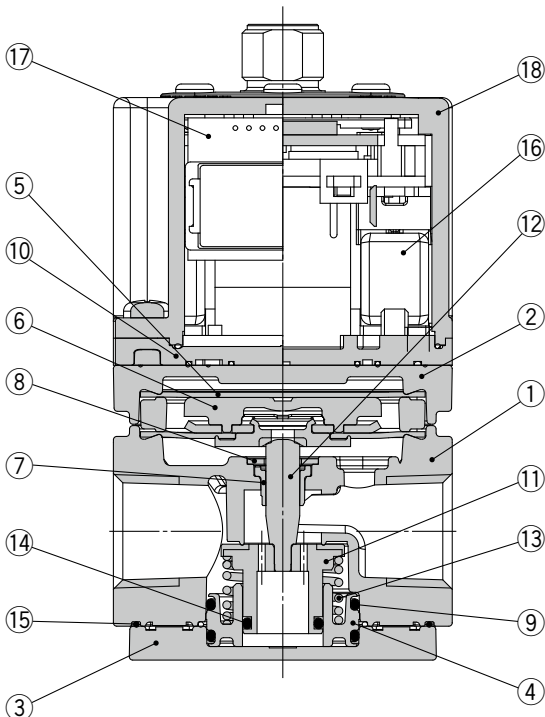

Main Component Parts

No.	Description	Material
◆ 1	Body	Aluminum alloy
2	Cover	Aluminum alloy
◆ 3	Base plate	Aluminum alloy
◆ 4	Valve guide	Resin
◆ 5	Supply diaphragm	Rubber
◆ 6	Diaphragm assembly	Resin/Rubber/Stainless steel/ Brass/Carbon steel
◆ 7	Stem guide	Resin
◆ 8	O-ring retainer	Aluminum alloy
◆ 9	Valve guide seal	HNBR
10	Sub-plate	Resin
◆ 11	Valve	Aluminum alloy/HNBR
◆ 12	Stem	Stainless steel
◆ 13	Valve spring	Stainless steel
◆ 14	Seal	HNBR
◆ 15	Exhaust seal	HNBR
16	Solenoid valve	—
17	Control circuit assembly	—
18	Bowl cover assembly	Resin/Silicone rubber

* ◆ indicates parts in contact with the fluid.
In the control circuit assembly, only the built-in pressure sensor is the part in contact with the fluid.

ITV1100/2100/3100 Series

Construction

ITV3100

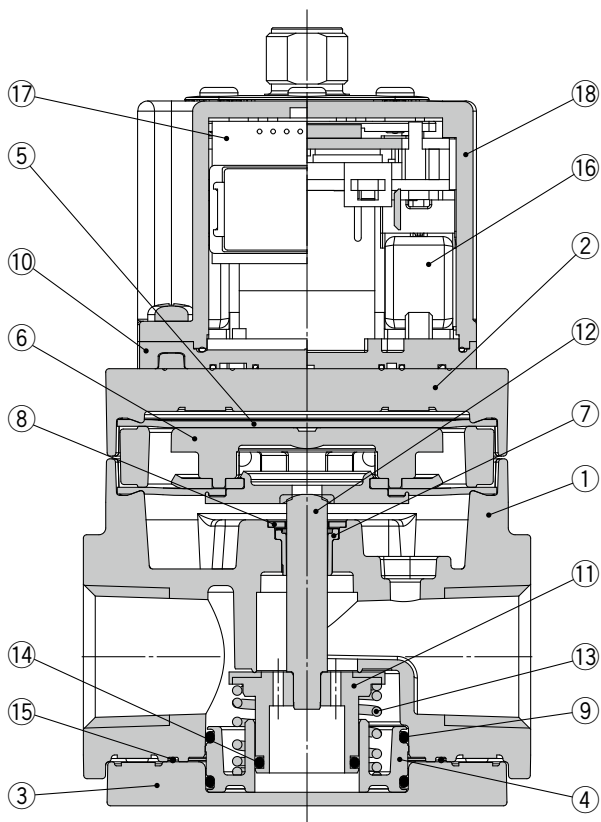

Main Component Parts

No.	Description	Material
◆ 1	Body	Aluminum alloy
2	Cover	Aluminum alloy
◆ 3	Base plate	Aluminum alloy
◆ 4	Valve guide	Resin
◆ 5	Supply diaphragm	Rubber
◆ 6	Diaphragm assembly	Resin/Rubber/Stainless steel/ Brass/Carbon steel
◆ 7	Stem guide	Resin
◆ 8	O-ring retainer	Aluminum alloy
◆ 9	Valve guide seal	HNBR
10	Sub-plate	Resin
◆ 11	Valve	Aluminum alloy/HNBR
◆ 12	Stem	Stainless steel
◆ 13	Valve spring	Stainless steel
◆ 14	Seal	HNBR
◆ 15	Exhaust seal	HNBR
16	Solenoid valve	—
17	Control circuit assembly	—
◆ 18	Bowl cover assembly	Resin/Silicone rubber

* ◆ indicates parts in contact with the fluid.

In the control circuit assembly, only the built-in pressure sensor is the part in contact with the fluid.

Electro-Pneumatic Regulator / High Flow Rate *ITV1100/2100/3100 Series*

Dimensions

ITV11□□

Flat bracket

* Do not attempt to rotate, as the cable connector does not turn.

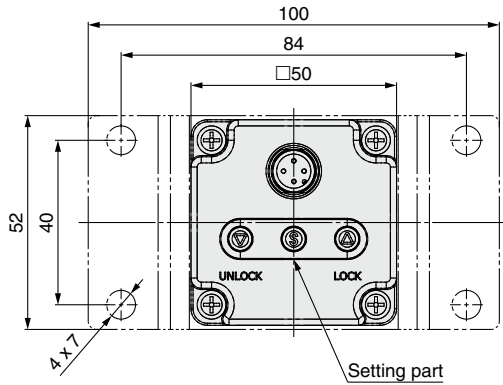

Right angle type (4 cores)
Cable connector 3 m

Straight type (4 cores)
Cable connector 3 m

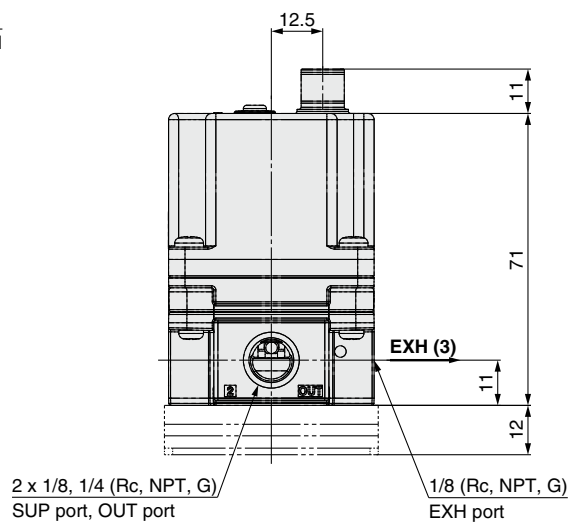
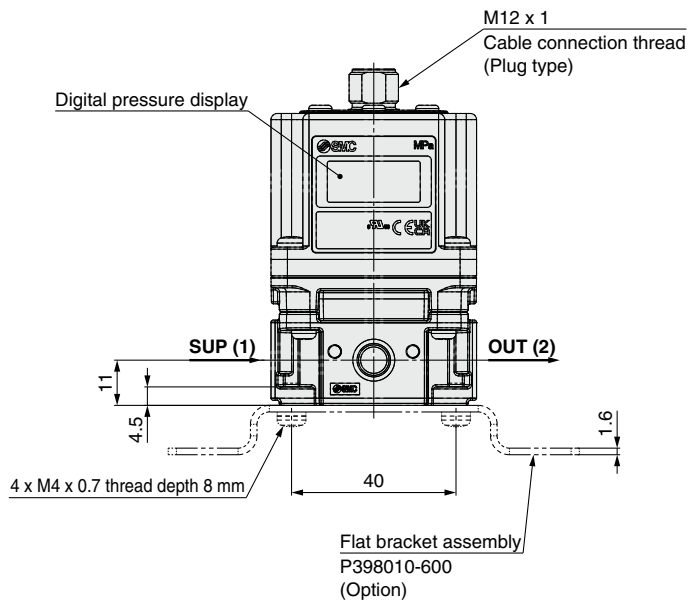
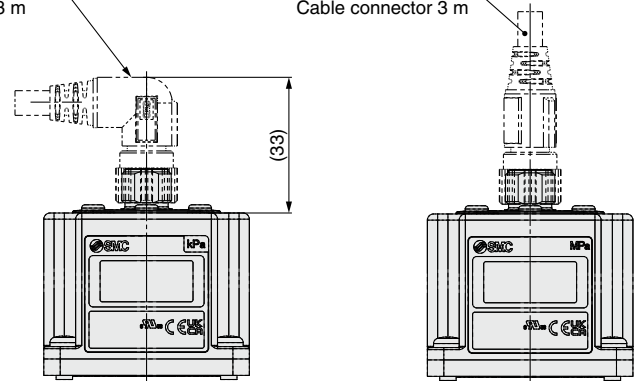

L-bracket

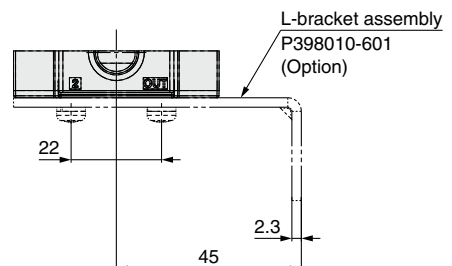
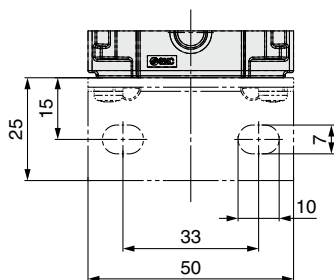

ITV1100/2100/3100 Series

Dimensions

ITV21□□

Flat bracket

* Do not attempt to rotate, as the cable connector does not turn.

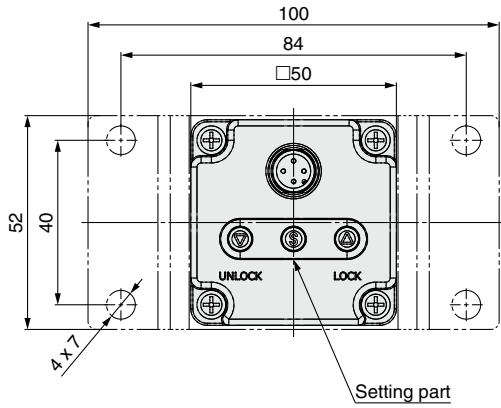

Right angle type (4 cores)
Cable connector 3 m

Straight type (4 cores)
Cable connector 3 m

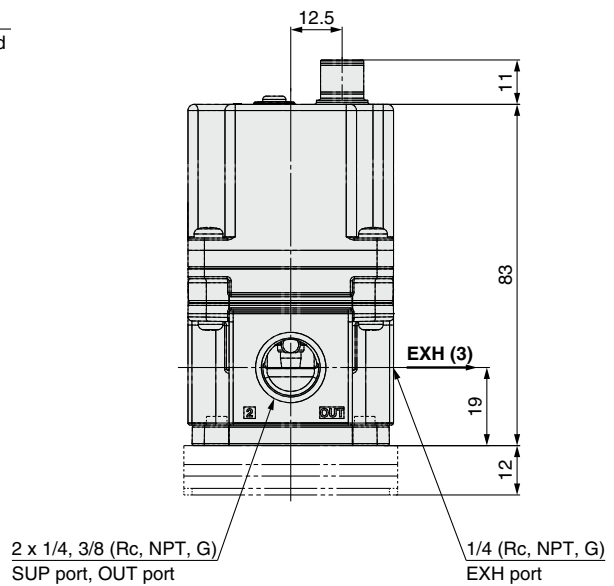
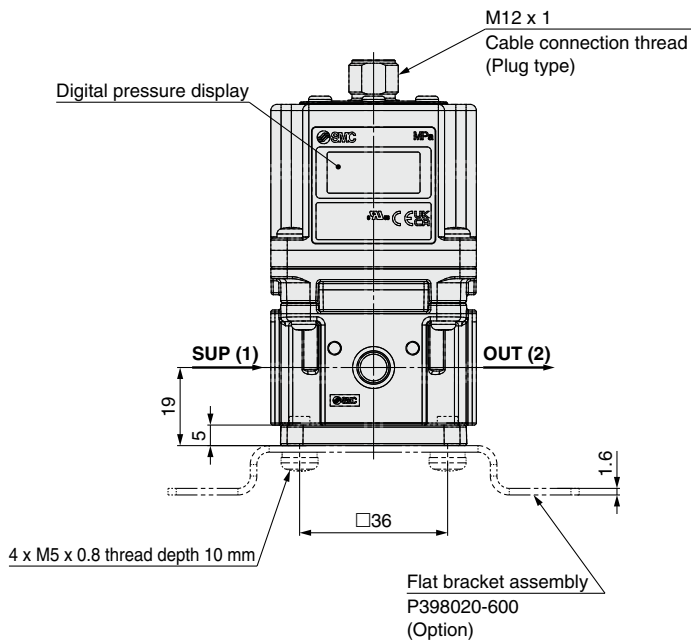
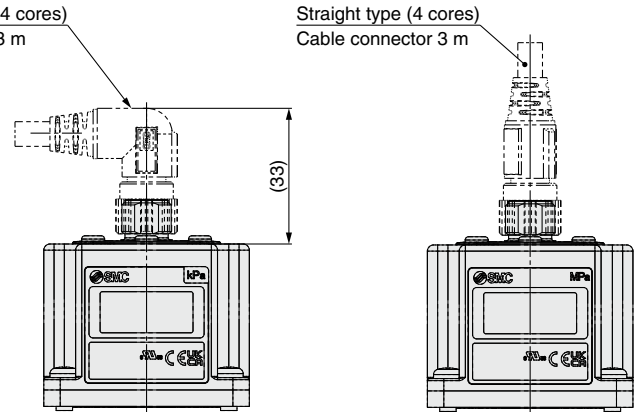

L-bracket

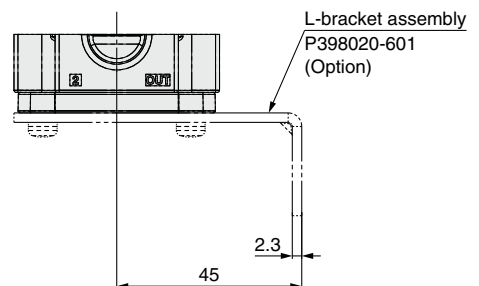
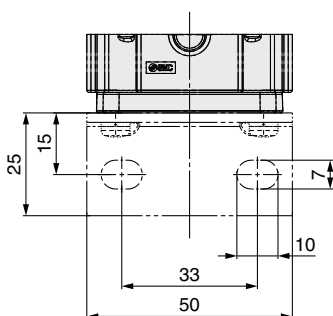

Electro-Pneumatic Regulator / High Flow Rate *ITV1100/2100/3100 Series*

Dimensions

ITV31□□

Flat bracket

* Do not attempt to rotate, as the cable connector does not turn.

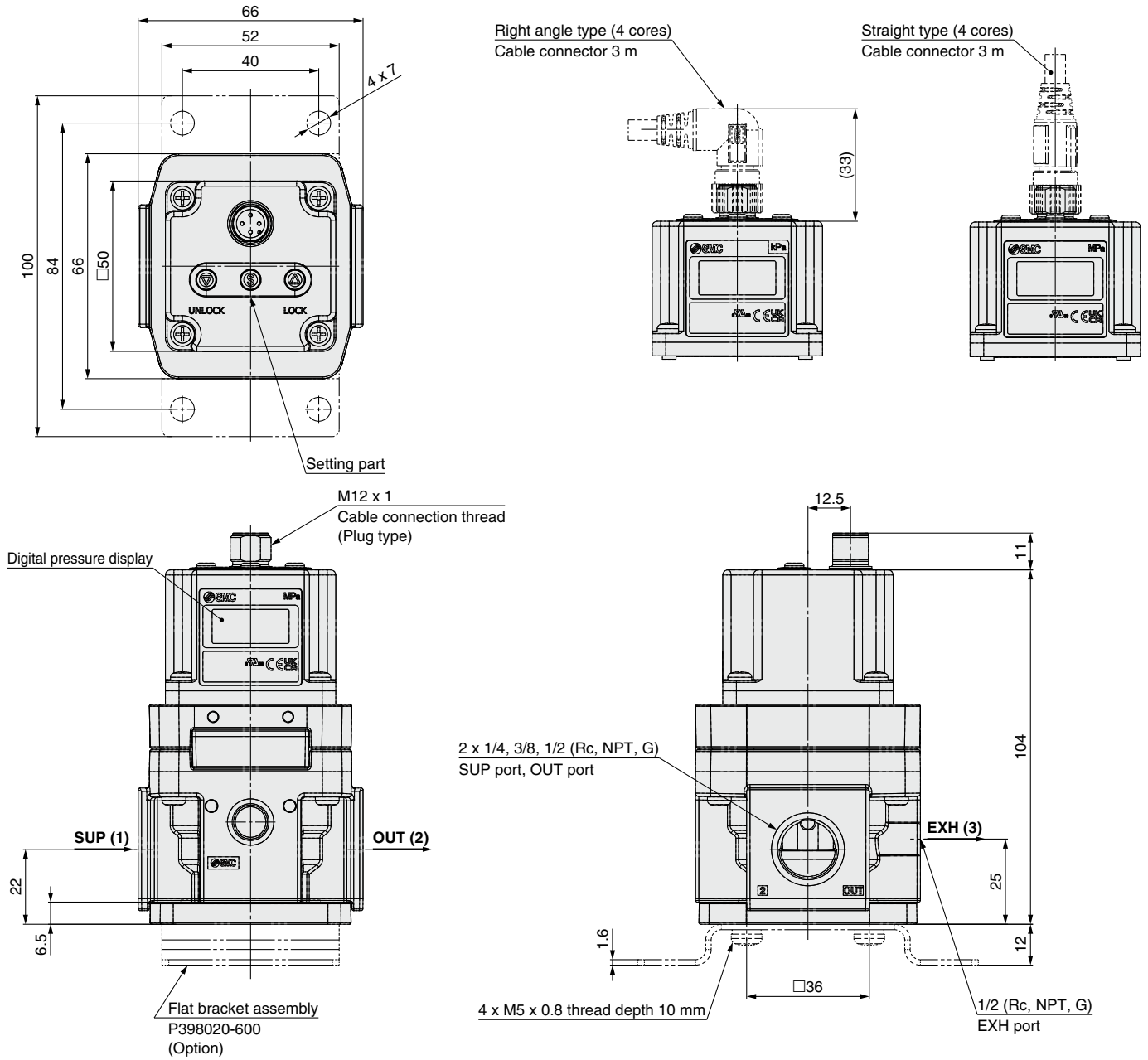

L-bracket

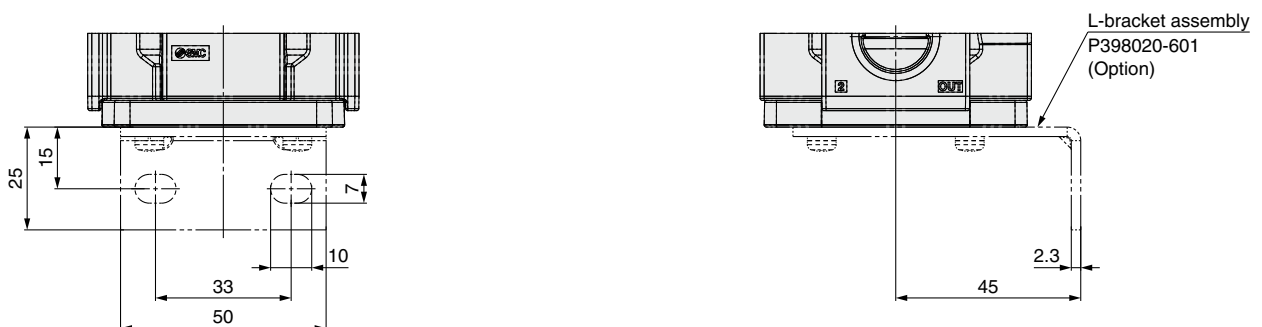



ITV1100/2100/3100 Series

Specific Product Precautions 1

Be sure to read this before handling the products. Refer to the back cover for safety instructions. For F.R.L. units precautions, refer to the “Handling Precautions for SMC Products” and the “Operation Manual” on the SMC website: <https://www.smcworld.com>

Piping

Warning

1. When screwing piping into a component, tighten within the recommended tightening torque range while holding the female thread side.

If the tightening torque is insufficient, looseness or sealing failure may occur. On the other hand, excess tightening torque can result in damage to the threads. Furthermore, tightening without holding the female thread side can result in damage due to the excess force that is applied directly to the piping bracket.

Recommended tightening torque range: N·m

Connection thread	1/8	1/4	3/8	1/2
Torque	3 to 5	8 to 12	15 to 20	20 to 25

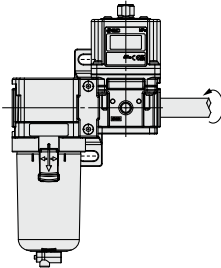

2. Avoid excessive torsional moment and bending moment other than those caused by the equipment's own weight, as failure to do so may result in damage.

Support external piping separately.

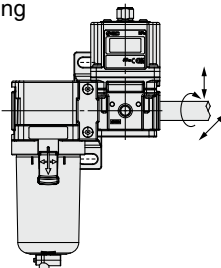

3. Piping materials which lack flexibility, such as steel tube piping, are prone to being affected by excess moment loads and vibrations from the piping side. Use flexible tubing in between to avoid such effects.

Caution

1. Preparation before piping

Before piping is connected, it should be thoroughly blown out with air (flushing) or washed to remove chips, cutting oil, and other debris from inside the pipe.

If chips, sealing material, or other debris enter into this product, the solenoid valve may buzz or the outlet pressure may not be output properly.

2. Winding of sealant tape

When screwing piping or fittings into ports, ensure that chips from the pipe threads or sealing material do not enter the piping. Also, if sealant tape is used, leave 1.5 to 2 thread ridges exposed at the end of the threads.

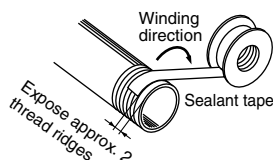

Operating Environment

Warning

1. Do not use in atmospheres containing corrosive gases, chemicals, sea water, or where there is direct contact with any of these.
2. Please contact SMC regarding use at power stations or in instrumentation applications.

Caution

1. When used in locations where the body of the product is exposed to water, water vapor, dust, etc., there is a possibility that moisture or dust could enter the body through the EXH port, thereby causing problems.
2. To prevent this, simply install tubing to each port, using the fittings, and extend the tubing so that the other end is in a location where no water splash, etc., occurs. Make sure not to bend or block the I.D. of the tubing as this will have a detrimental effect on the pressure control.
3. Do not use in places subject to heavy vibration and/or impact.
4. The product should not be exposed to prolonged sunlight. Use a protective cover if this is unavoidable.
5. Remove any sources of excessive heat.
6. In locations where there is contact with water, oil, weld spatter, etc., take suitable protective measures.

Air Supply

Warning

1. Please contact SMC when using the product in an application using a fluid other than compressed air.
2. Do not use compressed air that contains chemicals, synthetic oils that include organic solvents, salt, corrosive gases, etc., as doing so may result in a malfunction.

Caution

1. Install an air filter near this product on the supply side. Select an air filter with a filtration size of 5 μm or smaller.
2. Compressed air that contains a large amount of drainage can cause the malfunction of this product and other pneumatic equipment. Therefore, take appropriate measures to ensure air quality, such as providing an aftercooler, air dryer, or water separator.
3. If excessive carbon dust is generated by the compressor, it may adhere to the inside of this product and cause it to malfunction.

Refer to the “SMC Air Preparation System” for further details on compressed air quality.



ITV1100/2100/3100 Series

Specific Product Precautions 2

Be sure to read this before handling the products. Refer to the back cover for safety instructions. For F.R.L. units precautions, refer to the “Handling Precautions for SMC Products” and the “Operation Manual” on the SMC website: <https://www.smcworld.com>

Handling

⚠ Caution

1. Do not use a lubricator on the supply side of this product, as doing so may result in a malfunction. When lubrication of terminal equipment is necessary, connect a lubricator on the output side of this equipment.
2. If electric power is shut off while pressure is being applied, pressure will be retained on the output side. However, this output pressure is held only temporarily and is not guaranteed. If exhausting of this pressure is desired, shut off the power after reducing the set pressure, and discharge the air using a residual pressure exhaust valve, etc.
3. If the power to this product is cut off due to a power failure, etc., when it is in a controlled state, output pressure will be retained temporarily. Handle carefully when operating with output pressure released to the atmosphere, as air will continue to flow out.
4. If supply pressure to this product is interrupted while the power is still on, the internal solenoid valve will continue to operate and a humming noise may be generated. Since the life of the product may be shortened, shut off the power supply also when supply pressure is shut off.
5. The output side pressure cannot be completely released from this product in the range below 0.005 MPa. In cases where the pressure needs to be reduced completely to 0 MPa, install a 3-port valve, etc., on the output side to discharge the residual pressure.
6. This product is adjusted for each specification at the time of shipment from the factory. Avoid careless disassembly or removal of parts, as failure to do so may result in a malfunction.
7. The optional cable connector is a 4-wire type. When the monitor output (analog output or switch output) is not being used, keep it from touching the other wires as doing so may result in a malfunction.
8. When connecting the cable to this product, turn the lock ring of the cable. If a portion other than the lock ring of the cable is turned, it may damage the connector on the body. Turn the lock ring by hand without using a tool.
9. The right angle cable does not rotate and is limited to only one entry direction. If the right angle cable is rotated forcibly, the cable may be broken or damaged, or may damage the connector on the body.
10. Take the following steps to avoid malfunction due to noise.
 - 1) Remove power supply noise during operation by installing a line filter, etc., in the AC power line.
 - 2) For avoiding the influence of noise or static electricity, install this product and its wiring as far as possible from strong electric fields such as those of motors, power lines, etc.
 - 3) Be sure to implement protective measures against load surge for induction loads (solenoid valves, relays, etc.).
11. Due to the large volume of the output side, do not use for the purpose of a relief function.
12. Specifications on page 5 are in case of static environment. Pressure may fluctuate when air is consumed at the output side.
13. For details on the handling of this product, refer to the operation manual which is included with the product.

Handling

⚠ Caution

14. This product does not have a shut-off valve function. If air pressure is supplied without electric power being applied, output pressure may increase to the pressure equivalent of the supply pressure. Operate the system to shut off the supply pressure when not operating the product.
15. The solenoid valves built into this product are consumables. Perform periodic maintenance in environments where the solenoid valves are operated at a high frequency.

Design / Selection

⚠ Caution

1. Use the following UL approved products for DC power supply combinations.
 - (1) Limited voltage current circuit in accordance with UL 508
A circuit in which power is supplied by the secondary coil of a transformer that meets the following conditions
 - Max. voltage (with no load): 30 Vrms (42.4 V peak) or less
 - Max. current:
 - (1) 8 A or less (including when short circuited)
 - (2) limited by circuit protector (such as fuse) with the following ratings
 - (2) A circuit (class 2 circuit) with max. 30 Vrms (42.4 V peak) or less, and a power supply consisting of a class 2 power supply unit conforming to UL1310, or a class 2 transformer conforming to UL1585
2. Operate these products only within the specified voltage.
Using voltages beyond the specified levels could result in faults or malfunctions.
3. Use 0 V as the baseline for the power supplied to the unit for output, control, and input.

No load voltage (V peak)	Max. current rating [A]
0 to 20 [V]	5.0
Over 20 and 30 or less [V]	100
	Peak voltage

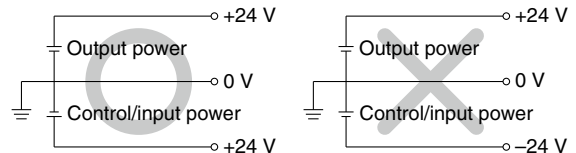

4. Each product needs to be powered by one power supply unit.
The wiring of this product has the same common between the GND for power and the signals; there is a possibility that a wrong current occurs and prevents a proper operation if one power supply unit controls multiple electro-pneumatic regulators.
5. Please contact SMC for the usage when the downstream side is released to atmosphere.

This product is a pressure controller. The downstream side being released to atmosphere makes the inlet valve full open, allowing a large amount of atmosphere flow into the body. Please contact SMC for the appropriate usage when you use the product under such condition since the product may not meet the specification or the life of the product may be shortened.



ITV1100/2100/3100 Series

Specific Product Precautions 3

Be sure to read this before handling the products. Refer to the back cover for safety instructions. For F.R.L. units precautions, refer to the “Handling Precautions for SMC Products” and the “Operation Manual” on the SMC website: <https://www.smcworld.com>

Wiring

⚠ Caution

Connect the cable to the connector on the body with the wiring arranged as shown below. Proceed carefully, as incorrect wiring can result in damage. For the DC power supply, use a stabilized power supply with sufficient capacity and a ripple rate of 1% or less.

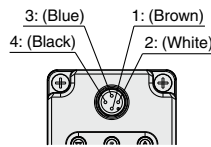
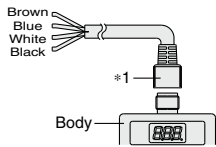

Current Signal Type Voltage Signal Type

1	Brown	Power supply
2	White	Input signal
3	Blue	GND (COMMON)
4	Black	Monitor output

Preset Input Type

1	Brown	Power supply
2	White	Input signal 1
3	Blue	GND (COMMON)
4	Black	Input signal 2

Wiring diagrams

Current signal type

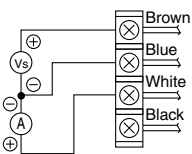

Vs : Power supply 24 VDC
12 to 15 VDC
A : Input signal 4 to 20 mADC
0 to 20 mADC

Voltage signal type

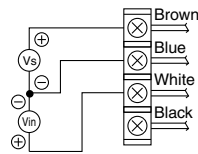

Vs : Power supply 24 VDC
12 to 15 VDC
Vin : Input signal 0 to 5 VDC
0 to 10 VDC

4 points preset input type

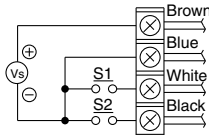

Vs : Power supply 24 VDC
12 to 15 VDC
(Negative common)

- * For safety reasons, it is recommended that one of the preset pressures be set to 0 MPa.
- * Preset pressures are set based on the min. unit for output display.

MPa	kgf/cm ²	bar	psi	kPa
0.001	0.01	0.01	0.1	1

· Note that this is 1 psi for 130 psi types.

Monitor output wiring diagrams

Analog output: Voltage type

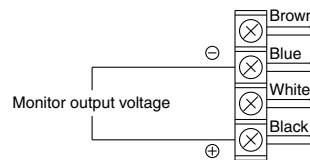

Analog output: Current type (Sink type)

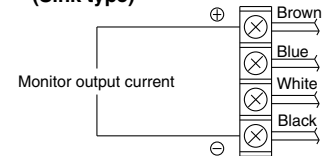

Switch output: NPN type

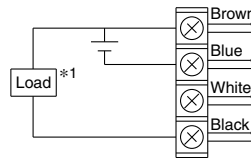

Switch output: PNP type

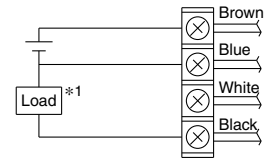

*1 When 80 mADC or more is applied, detecting device for overcurrent starts activating and then emits an error signal. (Error number “5”)

Set Pressure Range

The set pressure range, by unit of standard measured pressure, is shown in the table below.

Set pressure range by unit of standard measured pressure

Unit	Set pressure range		
	ITV□11□	ITV□13□	ITV□15□
MPa	0.005 to 0.1	0.005 to 0.5	0.005 to 0.9
kgf/cm ²	0.05 to 1	0.05 to 5	0.05 to 9
bar	0.05 to 1	0.05 to 5	0.05 to 9
psi	0.7 to 15	0.7 to 70	0.7 to 130
kPa	5 to 100	5 to 500	5 to 900

Return of Product

⚠ Warning

If the product to be returned is contaminated or is possibly contaminated with substances that are harmful to humans, for safety reasons, please contact SMC beforehand and then employ a specialist cleaning company to decontaminate the product. After the decontamination prescribed above has been carried out, submit a Product Return Request Sheet or the Detoxification/Decontamination Certificate to SMC and await SMC's approval and further instructions before attempting to return the item.

Please refer to the International Chemical Safety Cards (ICSC) for a list of harmful substances.

If you have any further questions, please don't hesitate to contact your SMC sales representative.

Safety Instructions

These safety instructions are intended to prevent hazardous situations and/or equipment damage. These instructions indicate the level of potential hazard with the labels of “**Caution**,” “**Warning**” or “**Danger**.” They are all important notes for safety and must be followed in addition to International Standards (ISO/IEC)*1), and other safety regulations.

 **Caution:** **Caution** indicates a hazard with a low level of risk which, if not avoided, could result in minor or moderate injury.

 **Warning:** **Warning** indicates a hazard with a medium level of risk which, if not avoided, could result in death or serious injury.

 **Danger :** **Danger** indicates a hazard with a high level of risk which, if not avoided, will result in death or serious injury.

*1) ISO 4414: Pneumatic fluid power – General rules relating to systems.
ISO 4413: Hydraulic fluid power – General rules relating to systems.
IEC 60204-1: Safety of machinery – Electrical equipment of machines.
(Part 1: General requirements)
ISO 10218-1: Manipulating industrial robots – Safety.
etc.

Warning

1. The compatibility of the product is the responsibility of the person who designs the equipment or decides its specifications.

Since the product specified here is used under various operating conditions, its compatibility with specific equipment must be decided by the person who designs the equipment or decides its specifications based on necessary analysis and test results. The expected performance and safety assurance of the equipment will be the responsibility of the person who has determined its compatibility with the product. This person should also continuously review all specifications of the product referring to its latest catalog information, with a view to giving due consideration to any possibility of equipment failure when configuring the equipment.

2. Only personnel with appropriate training should operate machinery and equipment.

The product specified here may become unsafe if handled incorrectly. The assembly, operation and maintenance of machines or equipment including our products must be performed by an operator who is appropriately trained and experienced.

3. Do not service or attempt to remove product and machinery/equipment until safety is confirmed.

1. The inspection and maintenance of machinery/equipment should only be performed after measures to prevent falling or runaway of the driven objects have been confirmed.
2. When the product is to be removed, confirm that the safety measures as mentioned above are implemented and the power from any appropriate source is cut, and read and understand the specific product precautions of all relevant products carefully.
3. Before machinery/equipment is restarted, take measures to prevent unexpected operation and malfunction.

4. Contact SMC beforehand and take special consideration of safety measures if the product is to be used in any of the following conditions.

1. Conditions and environments outside of the given specifications, or use outdoors or in a place exposed to direct sunlight.
2. Installation on equipment in conjunction with atomic energy, railways, air navigation, space, shipping, vehicles, military, medical treatment, combustion and recreation, or equipment in contact with food and beverages, emergency stop circuits, clutch and brake circuits in press applications, safety equipment or other applications unsuitable for the standard specifications described in the product catalog.
3. An application which could have negative effects on people, property, or animals requiring special safety analysis.
4. Use in an interlock circuit, which requires the provision of double interlock for possible failure by using a mechanical protective function, and periodical checks to confirm proper operation.

Caution

1. The product is provided for use in manufacturing industries.

The product herein described is basically provided for peaceful use in manufacturing industries.
If considering using the product in other industries, consult SMC beforehand and exchange specifications or a contract if necessary.
If anything is unclear, contact your nearest sales branch.

Limited warranty and Disclaimer/ Compliance Requirements

The product used is subject to the following “Limited warranty and Disclaimer” and “Compliance Requirements”.

Read and accept them before using the product.

Limited warranty and Disclaimer

1. The warranty period of the product is 1 year in service or 1.5 years after the product is delivered, whichever is first.*2)
Also, the product may have specified durability, running distance or replacement parts. Please consult your nearest sales branch.
2. For any failure or damage reported within the warranty period which is clearly our responsibility, a replacement product or necessary parts will be provided.
This limited warranty applies only to our product independently, and not to any other damage incurred due to the failure of the product.
3. Prior to using SMC products, please read and understand the warranty terms and disclaimers noted in the specified catalog for the particular products.

*2) Vacuum pads are excluded from this 1 year warranty.

A vacuum pad is a consumable part, so it is warranted for a year after it is delivered.
Also, even within the warranty period, the wear of a product due to the use of the vacuum pad or failure due to the deterioration of rubber material are not covered by the limited warranty.

Compliance Requirements

1. The use of SMC products with production equipment for the manufacture of weapons of mass destruction (WMD) or any other weapon is strictly prohibited.
2. The exports of SMC products or technology from one country to another are governed by the relevant security laws and regulations of the countries involved in the transaction. Prior to the shipment of a SMC product to another country, assure that all local rules governing that export are known and followed.

Caution

SMC products are not intended for use as instruments for legal metrology.

Measurement instruments that SMC manufactures or sells have not been qualified by type approval tests relevant to the metrology (measurement) laws of each country. Therefore, SMC products cannot be used for business or certification ordained by the metrology (measurement) laws of each country.

Safety Instructions

Be sure to read the “Handling Precautions for SMC Products” (M-E03-3) and “Operation Manual” before use.

SMC Corporation

Akihabara UDX 15F,
4-14-1, Sotokanda, Chiyoda-ku, Tokyo 101-0021, JAPAN
Phone: 03-5207-8249 Fax: 03-5298-5362
<https://www.smcworld.com>
© 2023 SMC Corporation All Rights Reserved

Specifications are subject to change without prior notice and any obligation on the part of the manufacturer.

D-G