

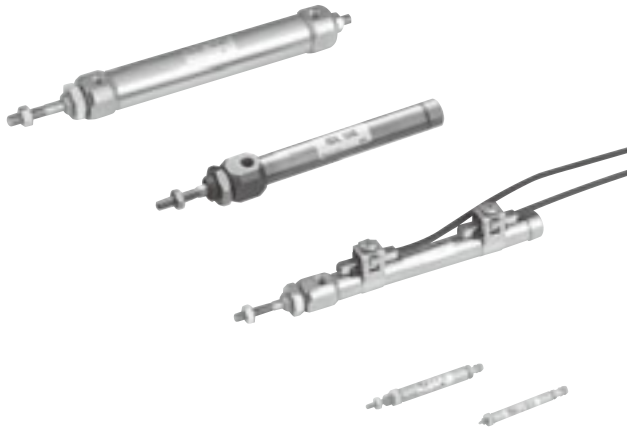

CAD drawing data catalog  
is available.



# KOGANEI

## ACTUATORS GENERAL CATALOG

PEN CYLINDERS

# PEN CYLINDERS CONTENTS

Features/Introductions of Variations	255
Handling Instructions and Precautions	257
Double Acting Type, Single Acting Push Type, Single Acting Pull Type	259
$\phi$ 2.5, $\phi$ 4 Single Acting Push Type	270
Non-rotating Cylinders	271
Double Rod Cylinders	276
Pull Side Stroke Adjusting Cylinders	280
Push Side Stroke Adjusting Cylinders	282
Heat Resistant Specification Cylinders	284
Low Hydraulic Cylinders	286
Dual Stroke Cylinders	288
Tandem Cylinders	290
Cylinders for Clean Systems	293
Cylinders with Variable Cushions	298
Linear Bearing Type Cylinders	301
Cylinders with Speed Controllers	304
Sensor Switches	307
Mounting Brackets/Rod End Accessories	310



**Caution**

Before use, be sure to read the "Safety Precautions" on p. 57.

The Pen Cylinder's compactness and easy handling make production lines in a broad range of industries. A new release with even lighter weight and more

# PEN CYLINDERS

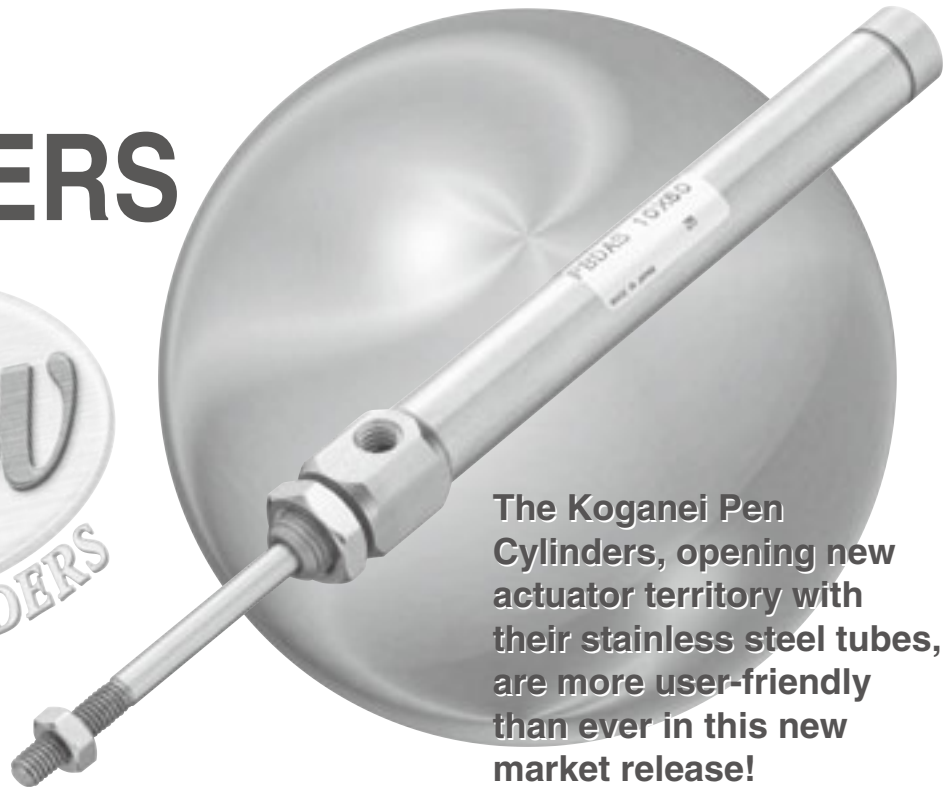

The Koganei Pen Cylinders, opening new actuator territory with their stainless steel tubes, are more user-friendly than ever in this new market release!

## Product series extended even more!

$\phi$  2.5,  $\phi$  4 Single Acting Push Type

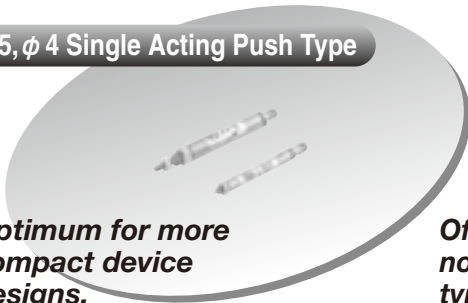

Optimum for more compact device designs.

Non-rotating Type

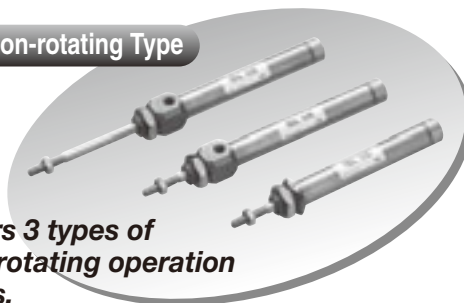

Offers 3 types of non-rotating operation types.

## LINE UP PRODUCTS

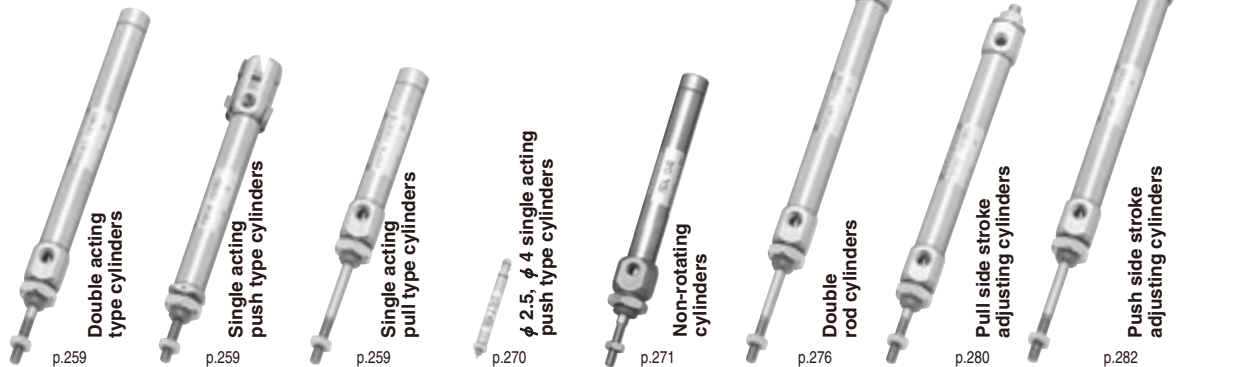

Bore size	p.259	p.259	p.259	p.270	p.271	p.276	p.280	p.282
2.5mm [0.098in.]				●				
4mm [0.157in.]				●				
6mm [0.236in.]	●	●	●					
10mm [0.394in.]	●	●	●		●	●	●	●
16mm [0.630in.]	●	●	●		●	●	●	●

it useful on

# durability in response to needs

## A Further 30% Weight Reduction

The brass parts for the both end covers and elsewhere have been changed to an aluminum alloy, achieving a 30% weight reduction from the earlier product.

(Double acting type,  $\phi$ 10, 60mm stroke: Previous product weighs 55g [1.94oz.], current Pen Cylinder weighs 33g [1.16oz.]



## Mounting is Straightforward and Easy

The shape of the end covers has been changed from round to square, allowing easy mounting with a wrench.



## 4mm Square Sensor Switch

Uses a 4mm [0.157in.] square sensor switch, optimum for saving space in the overall device.

Note: Not available with the  $\phi$  2.5,  $\phi$  4 single acting push types.



## 10% More Compact

Reduced body dimensions achieves space savings overall, and greater compactness in the user's device.

(For double acting type at  $\phi$ 10, and with 60mm stroke of cylinder with magnet)



Current Pen Cylinders



Previous Pen Cylinders

## Wear Resistance Up 200%

The rod bushing uses a special aluminum alloy with superior wear resistance. Cylinder life has been improved by 200% over the previous model.

## Conforms to Non-ion as Standard

Can be used on cathode-ray tube (CRT) manufacturing lines, etc., since copper materials<sup>Note</sup> are not used.

(Note: A portion of the materials used in the cylinders with speed controllers is to be nickel-plated.)

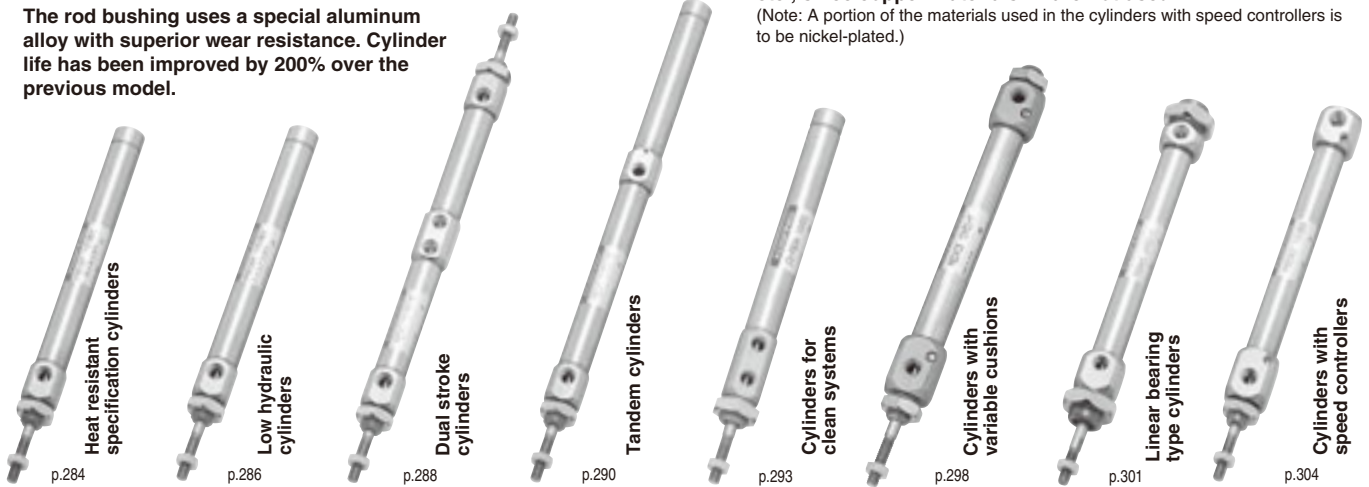

●	●			●				
●	●	●	●	●	○	○		○
●	●	●	●	●	○	○		○

White circle mark shows products on order.

## Handling Instructions and Precautions



### General precautions

#### Mounting

Tighten the mounting nuts to the recommended tightening torques shown below.

Thread size mm	Recommended tightening torque N·cm [in·lbf]
M6×1	240 [21]
M8×1	600 [53]
M10×1	1200 [106]

#### Piping to single acting type cylinders

Piping directly to single acting type cylinders for air supply can cause the unit to exceed the speed range, and damage the cylinder. Always use a speed controller with meter-in control to ensure that the speed range can ensure the allowable kinetic energy or less.

#### Media

1. Always thoroughly blow off (use compressed air) the tubing before piping. Entering chips, sealing tape, rust, etc., generated during piping work could result in air leaks or other defective operation.
2. Use air for the media. For the use of any other media, consult us.
3. Air used for the cylinder should be clean air that contains no deteriorated compressor oil, etc. Install an air filter (filtration of a minimum 40 μm) near the cylinder or valve to remove collected liquid or dust. In addition, drain the air filter periodically.  
Collected liquid or dust entering the cylinder may cause improper operation.

#### Lubrication

The product can be used without lubrication, if lubrication is required, use Turbine Oil Class 1 (ISO VG32) or equivalent. Avoid using spindle oil or machine oil.

#### Atmosphere

If using in locations subject to dripping water, dripping oil, etc., or to large amounts of dust, use a cover to protect the unit.

# Cylinder Thrust

Select a suitable bore size considering the load and air pressure to obtain the required thrust.  
 Since the figures in the table are calculated values, select a bore size that results in a load ratio (load ratio =  $\frac{\text{Load}}{\text{Calculated value}}$ ) of 70% or less (50% or less for high speed application).

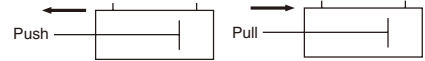

Bore size mm [in.]	Piston rod diameter mm [in.]	Operation type	Pressure area mm <sup>2</sup> [in. <sup>2</sup> ]	Air pressure MPa [psi.]							
				0.1 [15]	0.2 [29]	0.3 [44]	0.4 [58]	0.5 [73]	0.6 [87]	0.7 [102]	
2.5 [0.098]	1 [0.039]	Single acting push type	4.9 [0.0076]	—	—	—	0.8 [0.18]	1.3 [0.29]	1.7 [0.38]	2.2 [0.49]	
4 [0.157]	2 [0.079]	Single acting push type	12.6 [0.0195]	—	—	—	2.2 [0.49]	3.5 [0.79]	4.8 [1.08]	6.0 [1.35]	
6 [0.236]	3 [0.118]	Single acting push type	28.3 [0.0439]	—	—	5.0 [1.12]	7.8 [1.75]	10.7 [2.41]	13.5 [3.03]	16.3 [3.66]	
		Single acting pull type	21.2 [0.0329]	—	—	2.9 [0.65]	5.0 [1.12]	7.1 [1.60]	9.2 [2.07]	11.3 [2.54]	
		Double acting type									
		Push side	28.3 [0.0439]	—	5.7 [1.28]	8.5 [1.91]	11.3 [2.54]	14.2 [3.19]	17.0 [3.82]	19.8 [4.45]	
		Pull side	21.2 [0.0329]	—	4.2 [0.94]	6.4 [1.44]	8.5 [1.91]	10.6 [2.38]	12.7 [2.85]	14.8 [3.33]	
10 [0.394]	4 [0.157]	Single acting push type	78.5 [0.1217]	—	—	—	—	—	—	—	
		Single acting pull type	66 [0.102]	—	—	7.3 [1.64]	13.9 [3.12]	20.5 [4.61]	27.1 [6.09]	33.7 [7.58]	
		Double acting type									
		Push side	78.5 [0.1217]	7.9 [1.78]	15.7 [3.53]	23.6 [5.31]	31.4 [7.06]	39.3 [8.83]	47.1 [10.59]	55.0 [12.36]	
		Pull side	66 [0.102]	6.6 [1.48]	13.2 [2.97]	19.8 [4.45]	26.4 [5.93]	33.0 [7.42]	39.6 [8.90]	46.2 [10.39]	
16 [0.630]	5 [0.197]	Single acting push type	201 [0.312]	—	—	—	—	—	—	—	
		Single acting pull type	181 [0.281]	—	—	—	—	—	—	—	
		Double acting type									
		Push side	201 [0.312]	20.1 [4.52]	40.2 [9.03]	60.3 [13.56]	80.4 [18.07]	100.5 [22.59]	120.6 [27.11]	140.7 [31.63]	
		Pull side	181 [0.281]	18.1 [4.07]	36.3 [8.16]	54.3 [12.21]	72.4 [16.28]	90.5 [20.34]	108.6 [24.41]	126.7 [28.48]	

PEN CYLINDERS

## Allowable Kinetic Energy

Pen cylinders include a cushioning mechanism. This mechanism is intended to reduce as much as possible the impact of pistons with high kinetic energy when they stop at the end of the stroke. There are 2 types of cushions, as shown below.

### ● Rubber bumpers (Standard equipment)

Rubber bumpers installed on both sides of the piston soften the impact at the end of the stroke, and absorb the impact noise during stopping, in response to high-frequency and high-speed operations. Note that a certain amount of rebound will occur at the end of the stroke on the cylinder with the rubber bumpers.

### ● Variable cushions

Use variable cushions for large load or high-speed operations that rubber bumpers cannot adequately absorb. The impact is absorbed by compressing air, when the piston stops at the end of the stroke. Since the cushioning stroke is included within the cylinder stroke, be careful to ensure that the cushioning is not performed excessively during cylinder applications of 25mm strokes or less. An excessive cushioning can result in too much time for each stroke, reducing efficiency. When operated at or below the absorbable kinetic energy shown in the table below, the cushion seal life is 1 million operations or more.

The kinetic energy of load can be obtained through the formulas shown below.

$E_x = \frac{m}{2} v^2$	$E'_x = \frac{W}{2g} v'^2$
Ex: Kinetic energy (J)	E'x: Kinetic energy [ft·lbf]
m: Load mass (kg)	W: Load [lbf.]
v: Piston speed (m/s)	v': Piston speed [ft./sec.]
	g: Acceleration of gravity 32.2 [ft./sec. <sup>2</sup> ]

### Operating speed range

- Rubber bumper .....50~750mm/s [2.0~29.5in./sec.]
- Variable cushion .....100~1000mm/s [3.9~39.4in./sec.]

Bore size mm [in.]	Allowable kinetic energy J [ft·lbf]	
	With rubber bumpers	With variable cushion
6 [0.236]	0.009 [0.0066]	—
10 [0.394]	0.015 [0.011]	0.07 [0.052]
16 [0.630]	0.04 [0.030]	0.18 [0.133]

### Rubber bumper (Graph 1)

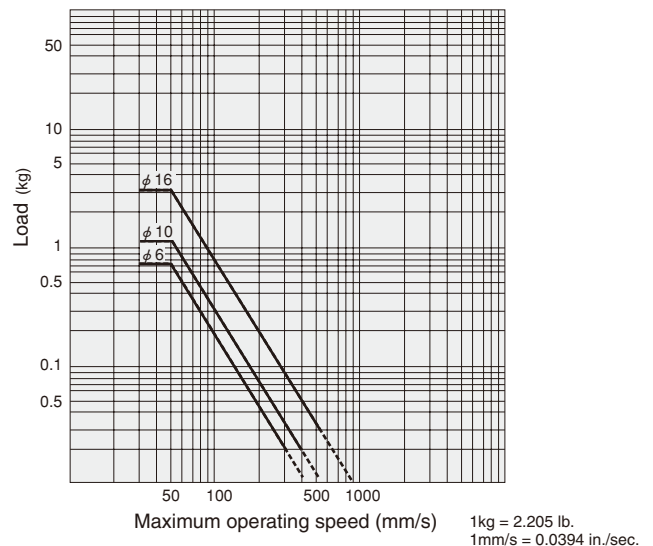

### Variable cushion (Graph 2)

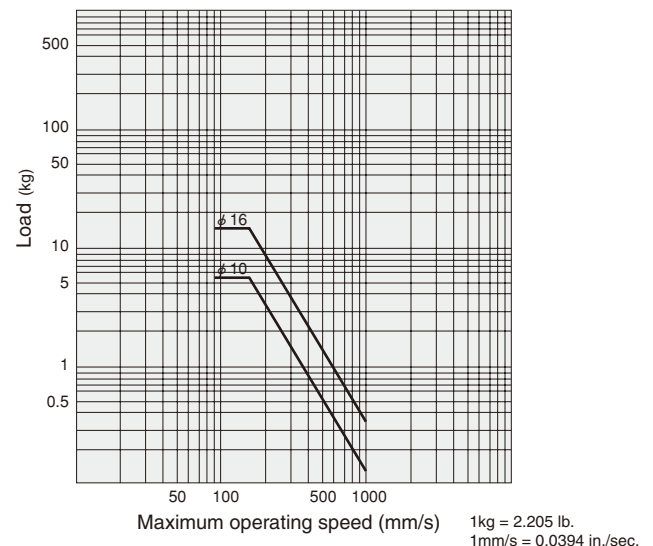

#### How to read graphs

From Graph 1, φ16 [0.630in.] with rubber bumpers is selected where the load is 1kg [2.2lb.] and the maximum operating speed is 90mm/s [3.54in./sec.].  
 From Graph 2, φ16 [0.630in.] with variable cushion is selected where the load is 2kg [4.4lb.] and the maximum operating speed is 400mm/s [15.7in./sec.].

# PEN CYLINDERS

Double Acting Type, Single Acting Push Type,  
Single Acting Pull Type

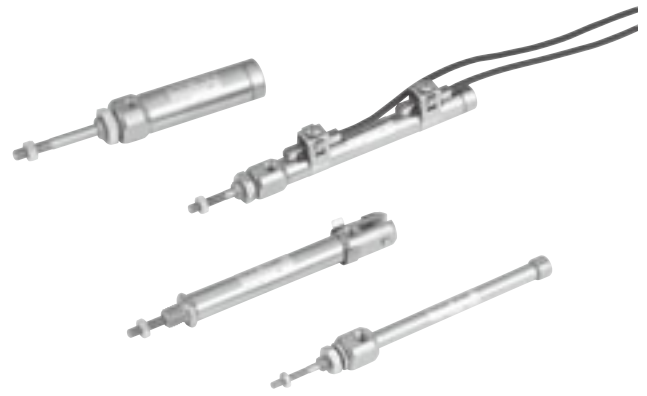

## Symbols

● Double acting type    ● Single acting push type



● Single acting pull type

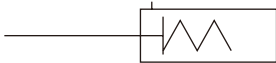

## Specifications

Item	Bore size mm [in.]	6 [0.236]	10 [0.394]	16 [0.630]
Operation type		Double acting type, Single acting push type, Single acting pull type		
Media		Air		
Mounting type		Basic type, Foot type, Flange type, Clevis type (clevis type of $\phi$ 10 and $\phi$ 16 only)		
Operating pressure range <sup>Note 1</sup>	MPa [psi.]	0.12~0.7 [17~102]	0.08~0.7 [12~102]	0.06~0.7 [9~102]
Proof pressure	MPa [psi.]	1.05 [152]		
Operating temperature range	°C [°F]	0~70 [32~158]		
Operating speed range	mm/s [in./sec.]	50~750 [2.0~29.5]		
Cushion		None	Rubber bumper	
Lubrication		Not required		
Port size		M5×0.8 <sup>Note 2</sup>		

Notes: 1. For details of each cylinder's operation type, see the table for the minimum operating pressure.

2. M3×0.5 can also be selected at  $\phi$  6 only.

## Bore Size and Stroke

● Double acting type				mm [in.]
Bore size	Standard strokes <sup>Note</sup>	Maximum available stroke	Stroke tolerance	
6	5, 10, 15, 20, 25, 30, 35, 40, 45, 50, 55, 60	100		
10	5, 10, 15, 20, 25, 30, 35, 40, 45, 50, 55, 60 75, 100, 125, 150	150		+1.5 0 [+0.059] 0
16	5, 10, 15, 20, 25, 30, 35, 40, 45, 50, 55, 60 75, 100, 125, 150, 175, 200	200		

● Single acting type					mm [in.]
Operation type	Bore size	Standard strokes <sup>Note</sup>	Maximum available stroke	Stroke tolerance	
Single acting push type	6	5, 10, 15, 20, 25, 30, 35, 40, 45, 50, 55, 60	75	+1.5 0 [+0.059] 0	
	10		105		
	16		120		
Single acting pull type	6	5, 10, 15, 20, 25, 30	30	+1.5 0 [+0.059] 0	
	10				
	16				

Note: For non-standard strokes:

For strokes divisible by 5, cylinder tube cutting is used.

For strokes not divisible by 5, collar packed to the next size up stroke of cylinder.

## Order Codes

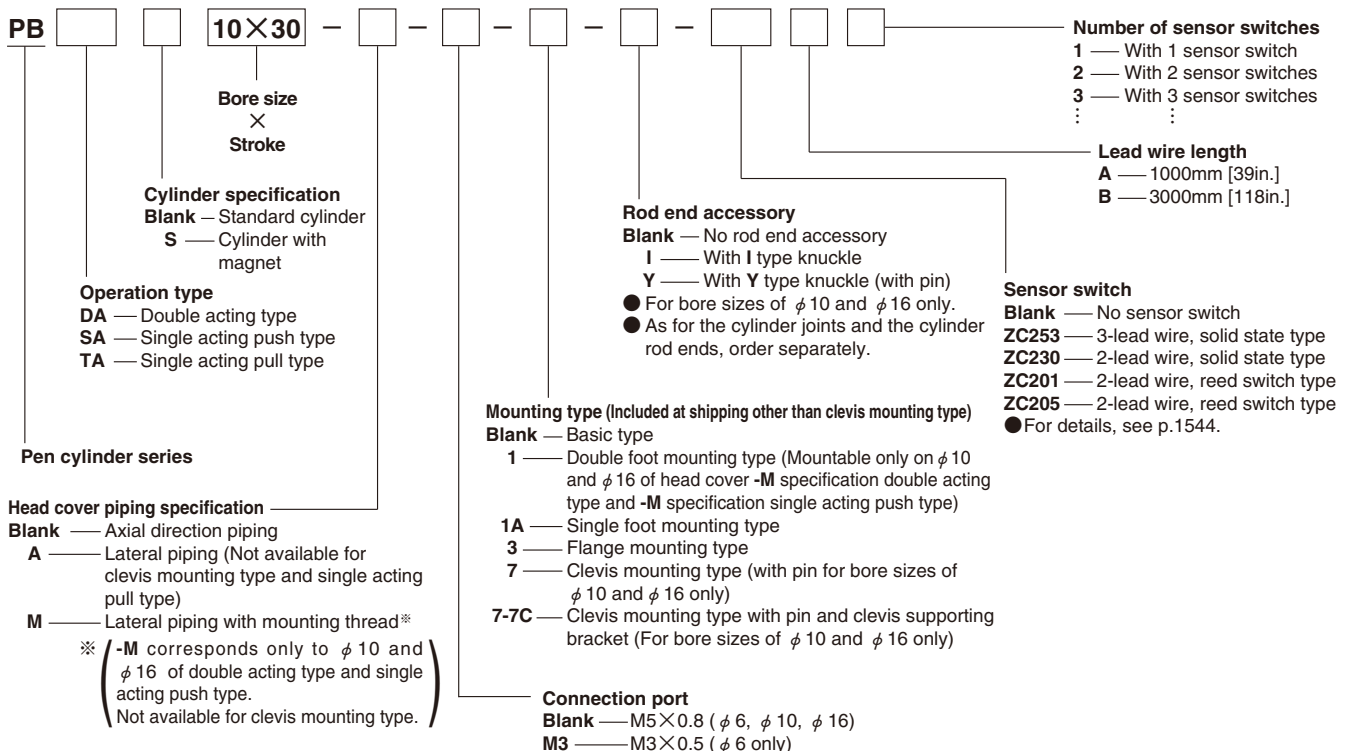



## Inner Construction (cannot be disassembled)

### ● Double acting type

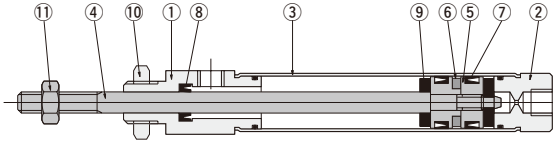

### ● Clevis mounting type (-7)

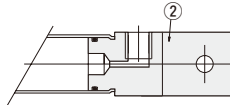

### ● Lateral piping (-A)

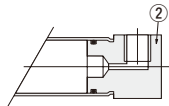

### ● Lateral piping with mounting thread (-M)

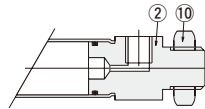

### ● Single acting push type

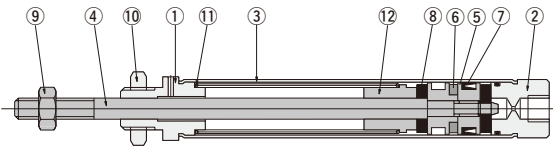

### ● Clevis mounting type (-7)

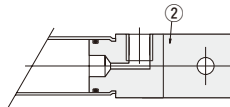

### ● Lateral piping (-A)

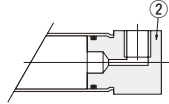

### ● Lateral piping with mounting thread (-M)

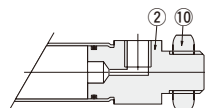

### ● Single acting pull type

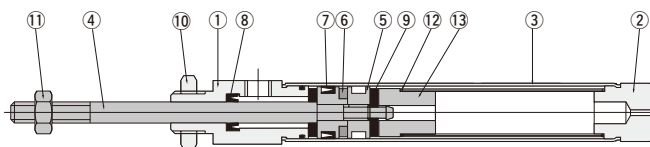

### ● Clevis mounting type (-7)

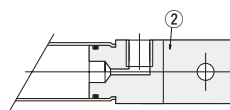

## Major Parts and Materials

No.	Parts	Materials
①	Rod cover	Aluminum alloy (nickel plated)
②	Head cover	
③	Cylinder tube	Stainless steel
④	Piston rod	
⑤	Piston	Aluminum alloy
⑥	Magnet <sup>Note1</sup>	Plastic magnet
⑦	Piston seal	Synthetic rubber (NBR)
⑧	Rod seal	
⑨	Bumper <sup>Note2</sup>	
⑩	Mounting nut	Mild steel (nickel plated)
⑪	Rod end nut	

Notes: 1. For cylinders with magnets. Standard cylinders do not have a built-in magnet for the sensor switch.  
2. Not available for bore size  $\phi 6$ .

No.	Parts	Materials
①	Rod cover	Aluminum alloy (nickel plated)
②	Head cover	
③	Cylinder tube	Stainless steel
④	Piston rod	
⑤	Piston	Aluminum alloy
⑥	Magnet <sup>Note1</sup>	Plastic magnet
⑦	Piston seal	Synthetic rubber (NBR)
⑧	Bumper <sup>Note2</sup>	
⑨	Rod end nut	Mild steel (nickel plated)
⑩	Mounting nut	
⑪	Spring	Steel
⑫	Collar	Aluminum alloy

Notes: 1. For cylinders with magnets. Standard cylinders do not have a built-in magnet for the sensor switch.  
2. Not available for bore size  $\phi 6$ .

No.	Parts	Materials
①	Rod cover	Aluminum alloy (nickel plated)
②	Head cover	
③	Cylinder tube	Stainless steel
④	Piston rod	
⑤	Piston	Aluminum alloy
⑥	Magnet <sup>Note1</sup>	Plastic magnet
⑦	Piston seal	Synthetic rubber (NBR)
⑧	Rod seal	
⑨	Bumper <sup>Note2</sup>	
⑩	Mounting nut	Mild steel (nickel plated)
⑪	Rod end nut	
⑫	Spring	Steel
⑬	Collar	Aluminum alloy

Notes: 1. For cylinders with magnets. Standard cylinders do not have a built-in magnet for the sensor switch.  
2. Not available for bore size  $\phi 6$ .



# Dimensions of Double Acting Type (mm)

Basic type PBDA  Bore size  Stroke

PBDA  Bore size

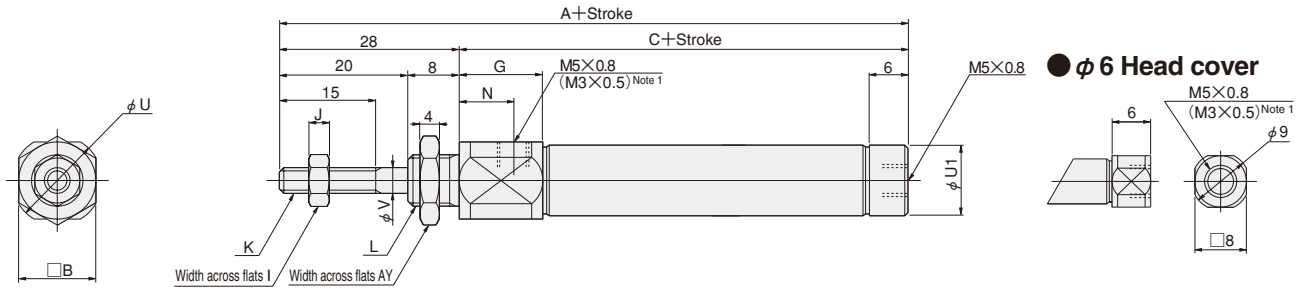

● Lateral piping (-A)  
PBDA  Bore size  Stroke -A

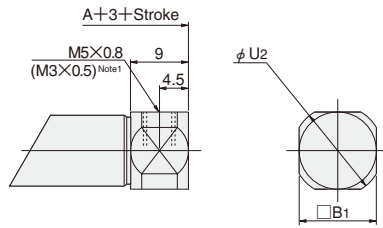

● Lateral piping with mounting thread (-M) Note 2  
PBDA  Bore size  Stroke -M

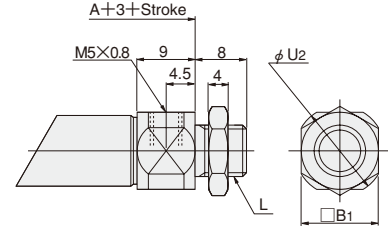

Bore mm [in.]	Code	A	C	B	B <sub>1</sub>	G	I	J	K	L	N	U	U <sub>1</sub>	U <sub>2</sub>	V	AY
6 [0.236]		77	49	12	12	14.5	5.5	2.4	M3×0.5	M6×1	10	14	—	14	3	10
10 [0.394]		71	43	12	12	13	7	3.2	M4×0.7	M8×1	8.5	14	11	14	4	12
16 [0.630]		71.5	43.5	17	17	11.5	8	4	M5×0.8	M10×1	7	19	17	19	5	14

Notes: 1. For bore size phi 6 only.  
2. Not available for bore size phi 6.

Single foot type PBDA  Bore size  Stroke -1A

PBDA  Bore size

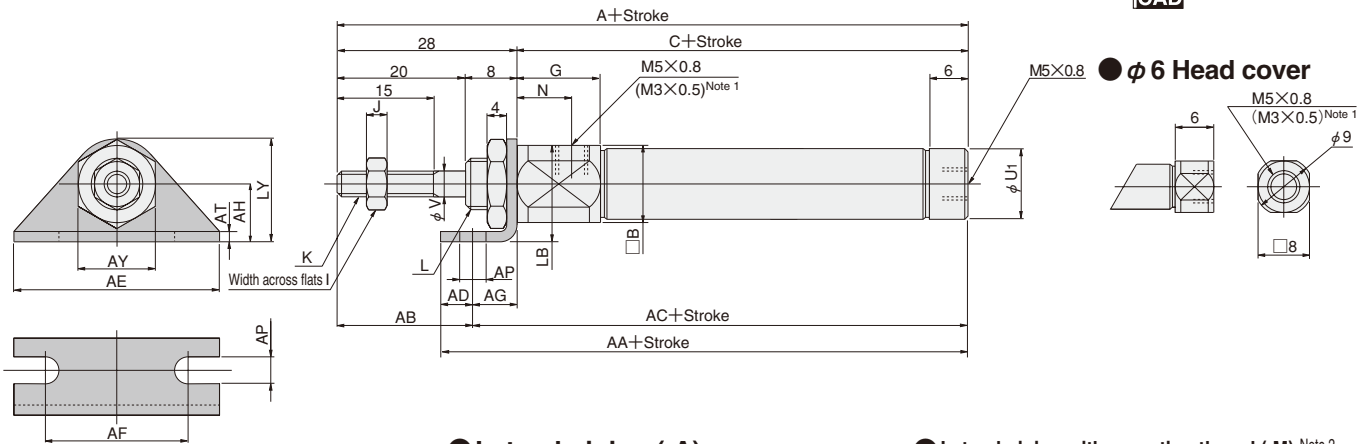

● Lateral piping (-A)  
PBDA  Bore size  Stroke -A-1A

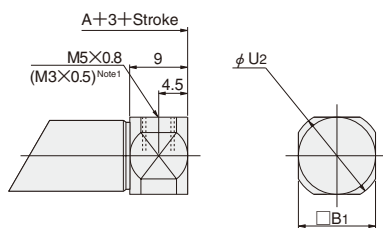

● Lateral piping with mounting thread (-M) Note 2  
PBDA  Bore size  Stroke -M-1A

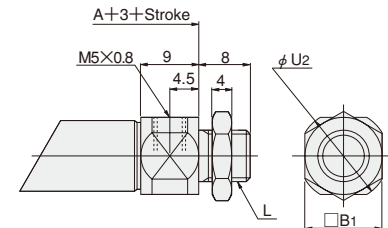

Bore mm [in.]	Code	A	B	C	B <sub>1</sub>	G	I	J	K	L	N	U <sub>1</sub>	U <sub>2</sub>	V	AA	AB	AC	AD	AE	AF	AG	AH
6 [0.236]		77	12	49	12	14.5	5.5	2.4	M3×0.5	M6×1	10	—	14	3	61	21	56	5	32	22.2	7	9
10 [0.394]		71	12	43	12	13	7	3.2	M4×0.7	M8×1	8.5	11	14	4	55	21	50	5	32	22.2	7	9
16 [0.630]		71.5	17	43.5	17	11.5	8	4	M5×0.8	M10×1	7	17	19	5	58.5	19	52.5	6	42	29.2	9	14

Bore mm [in.]	Code	AP	AT	AY	LB	LY
6 [0.236]		4.2	1.6	10	15	16
10 [0.394]		4.2	1.6	12	15	16
16 [0.630]		5.2	2.3	14	22.5	24

Notes: 1. For bore size phi 6 only.  
2. Not available for bore size phi 6.

# Dimensions of Double Acting Type (mm)

Double foot type PBDA  Bore size  × Stroke  -M-1

PBDA  Bore size

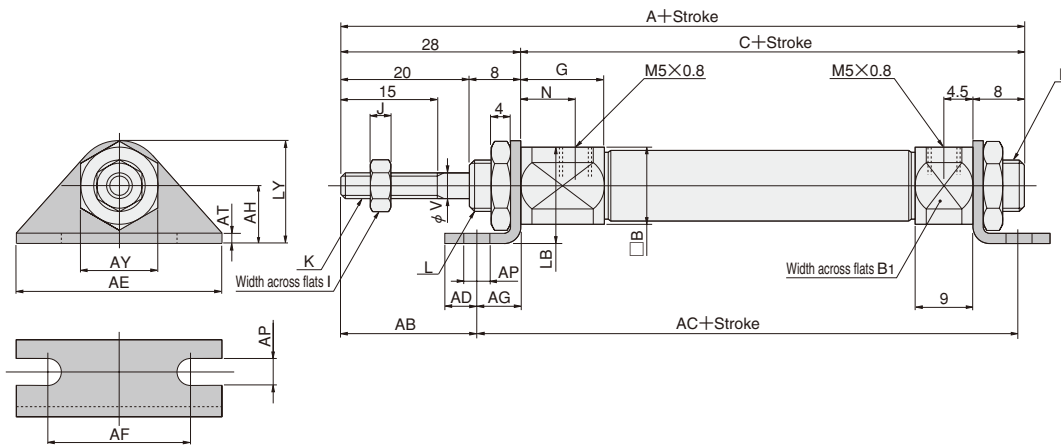

Bore mm (in.)	Code	A	C	B	B <sub>1</sub>	G	I	J	K	L	N	V	AB	AC	AD	AE	AF	AG	AH	AP	AT	AY	LB	LY
10 [0.394]		82	54	12	12	13	7	3.2	M4×0.7	M8×1	8.5	4	21	60	5	32	22.2	7	9	4.2	1.6	12	15	16
16 [0.630]		82.5	54.5	17	17	11.5	8	4	M5×0.8	M10×1	7	5	19	64.5	6	42	29.2	9	14	5.2	2.3	14	22.5	24

Flange type PBDA  Bore size  × Stroke  -3

PBDA  Bore size

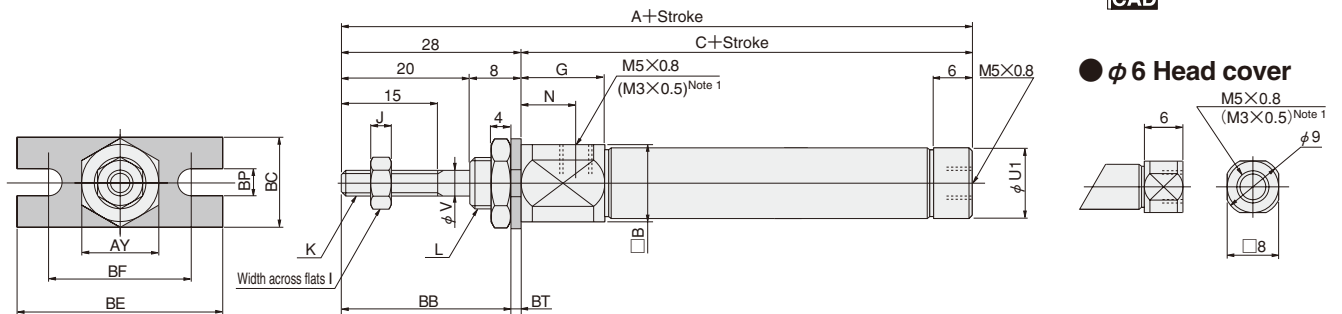

● Lateral piping (-A)  
PBDA  Bore size  × Stroke  -A-3

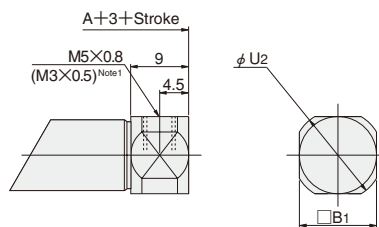

● Lateral piping with mounting thread (-M) Note 2  
PBDA  Bore size  × Stroke  -M-3

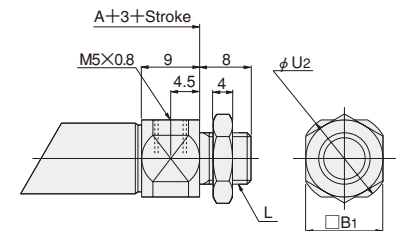

Bore mm (in.)	Code	A	C	B	B <sub>1</sub>	G	I	J	K	L	N	U <sub>1</sub>	U <sub>2</sub>	V	AY	BB	BC	BE	BF	BP	BT
6 [0.236]		77	49	12	12	14.5	5.5	2.4	M3×0.5	M6×1	10	—	14	3	10	26.4	14	32	22.2	4.2	1.6
10 [0.394]		71	43	12	12	13	7	3.2	M4×0.7	M8×1	8.5	11	14	4	12	26.4	14	32	22.2	4.2	1.6
16 [0.630]		71.5	43.5	17	17	11.5	8	4	M5×0.8	M10×1	7	17	19	5	14	25.7	20	42	29.2	5.2	2.3

Notes: 1. For bore size φ 6 only.  
2. Not available for bore size φ 6.

# Dimensions of Double Acting Type (mm)

● Clevis mounting type PBDA  Bore size  ×  Stroke  -7

 PBDA  Bore size  7

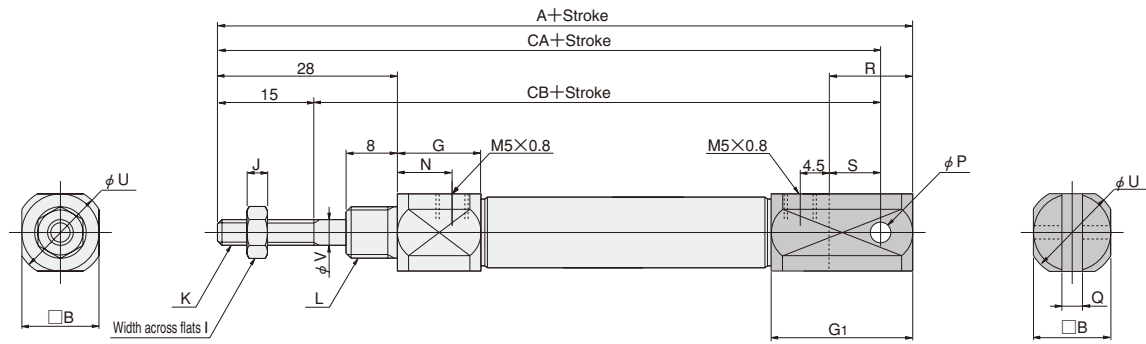

PEN CYLINDERS

Bore mm (in.)	Code	A	B	G	G <sub>1</sub>	I	J	K	L	N	P	Q	R	S	U	V	CA	CB
10	[0.394]	87	12	13	22	7	3.2	M4×0.7	M8×1	8.5	3.2 <sup>+0.09</sup> / <sub>+0.06</sub>	3.2 <sup>+0.2</sup> / <sub>+0.1</sub>	13	8	14	4	82	67
16	[0.630]	92.5	17	11.5	27	8	4	M5×0.8	M10×1	7	5 <sup>+0.09</sup> / <sub>+0.06</sub>	6.5 <sup>+0.2</sup> / <sub>+0.1</sub>	18	10	19	5	84.5	69.5

# Dimensions of Single Acting Push Type (mm)

● Basic type PBSA  Bore size  ×  Stroke

PBSA  Bore size

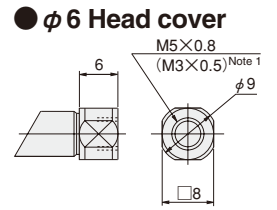
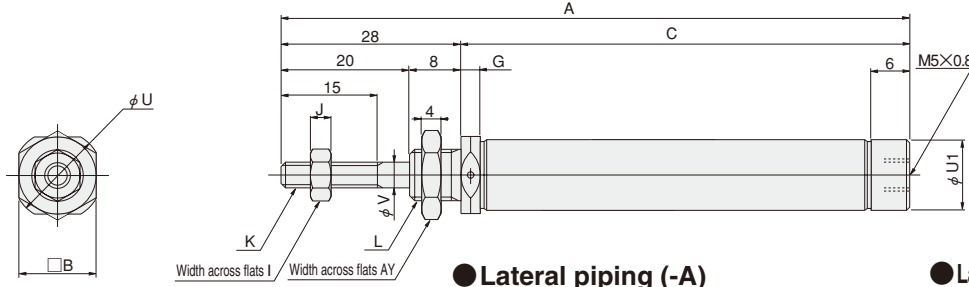

● Lateral piping (-A)

PBSA  Bore size  ×  Stroke -A

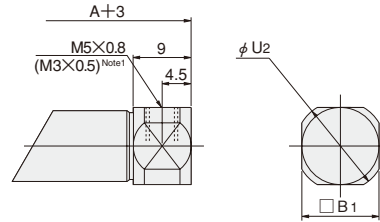

● Lateral piping with mounting thread (-M) Note 2

PBSA  Bore size  ×  Stroke -M

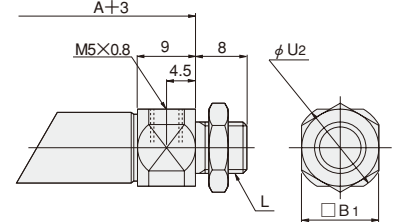

Notes: 1. For bore size  $\phi 6$  only.  
2. Not available for bore size  $\phi 6$ .

Code Stroke Bore mm [in.]	A												C											
	5	10	15	20	25	30	35	40	45	50	55	60	5	10	15	20	25	30	35	40	45	50	55	60
<b>6 [0.236]</b>	72	77	82	92	97	102	122	127	132	137	142	147	44	49	54	64	69	74	94	99	104	109	114	119
<b>10 [0.394]</b>	71	76	81	91	96	101	116	121	126	131	136	141	43	48	53	63	68	73	88	93	98	103	108	113
<b>16 [0.630]</b>	76.5	81.5	86.5	96.5	101.5	106.5	121.5	126.5	131.5	136.5	141.5	146.5	48.5	53.5	58.5	68.5	73.5	78.5	93.5	98.5	103.5	108.5	113.5	118.5

Code Stroke Bore mm [in.]	B	B <sub>1</sub>	G	I	J	K	L	U	U <sub>1</sub>	U <sub>2</sub>	V	AY
	<b>6 [0.236]</b>	8	8	4.5	5.5	2.4	M3×0.5	M6×1	9	—	10.8	3
<b>10 [0.394]</b>	12	12	3	7	3.2	M4×0.7	M8×1	14	11	14	4	12
<b>16 [0.630]</b>	17	17	6.5	8	4	M5×0.8	M10×1	19	17	19	5	14

● Single foot type PBSA  Bore size  ×  Stroke -1A

PBSA  Bore size

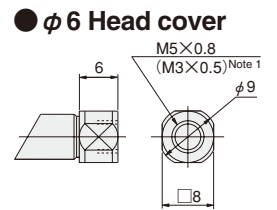
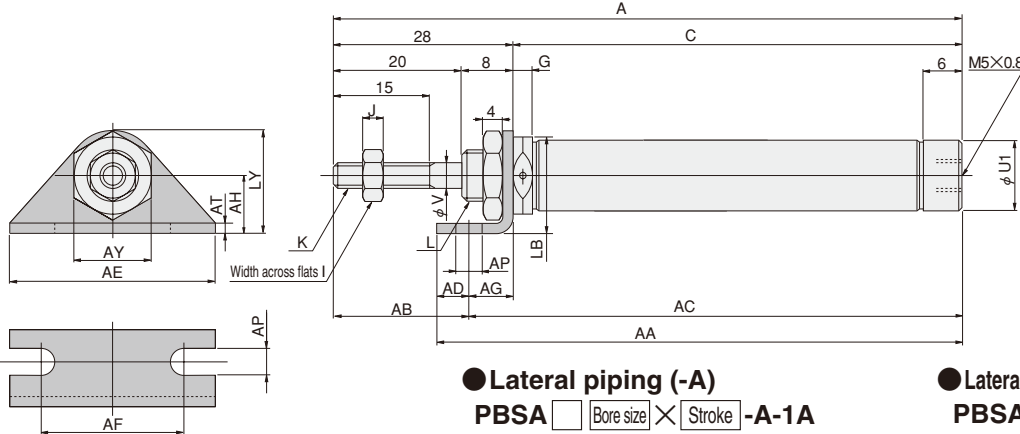

● Lateral piping (-A)

PBSA  Bore size  ×  Stroke -A-1A

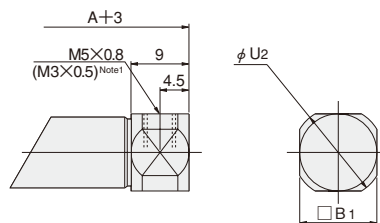

● Lateral piping with mounting thread (-M) Note 2

PBSA  Bore size  ×  Stroke -M-1A

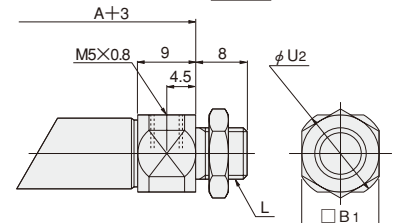

Notes: 1. For bore size  $\phi 6$  only.  
2. Not available for bore size  $\phi 6$ .

Code Stroke Bore mm [in.]	A												C												AA											
	5	10	15	20	25	30	35	40	45	50	55	60	5	10	15	20	25	30	35	40	45	50	55	60	5	10	15	20	25	30	35	40	45	50	55	60
<b>6 [0.236]</b>	72	77	82	92	97	102	122	127	132	137	142	147	44	49	54	64	69	74	94	99	104	109	114	119	56	61	66	76	81	86	106	111	116	121	126	131
<b>10 [0.394]</b>	71	76	81	91	96	101	116	121	126	131	136	141	43	48	53	63	68	73	88	93	98	103	108	113	55	60	65	75	80	85	100	105	110	115	120	125
<b>16 [0.630]</b>	76.5	81.5	86.5	96.5	101.5	106.5	121.5	126.5	131.5	136.5	141.5	146.5	48.5	53.5	58.5	68.5	73.5	78.5	93.5	98.5	103.5	108.5	113.5	118.5	63.5	68.5	73.5	83.5	88.5	93.5	108.5	113.5	118.5	123.5	128.5	133.5

Code Stroke Bore mm [in.]	AC												B <sub>1</sub>	G	I	J	K	L	U <sub>1</sub>	U <sub>2</sub>	V	AB	AD	AE	AF	AG	AH	AP	AT	AY	LB	LY
	<b>6 [0.236]</b>	51	56	61	71	76	81	101	106	111	116	121	126	8	4.5	5.5	2.4	M3×0.5	M6×1	—	10.8	3	21	5	32	22.2	7	9	4.2	1.6	10	13
<b>10 [0.394]</b>	50	55	60	70	75	80	95	100	105	110	115	120	12	3	7	3.2	M4×0.7	M8×1	11	14	4	21	5	32	22.2	7	9	4.2	1.6	12	15	16
<b>16 [0.630]</b>	57.5	62.5	67.5	77.5	82.5	87.5	102.5	107.5	112.5	117.5	122.5	127.5	17	6.5	8	4	M5×0.8	M10×1	17	19	5	19	6	42	29.2	9	14	5.2	2.3	14	22.5	24

# Dimensions of Single Acting Push Type (mm)

Double foot type PBSA  Bore size  × Stroke  -M-1

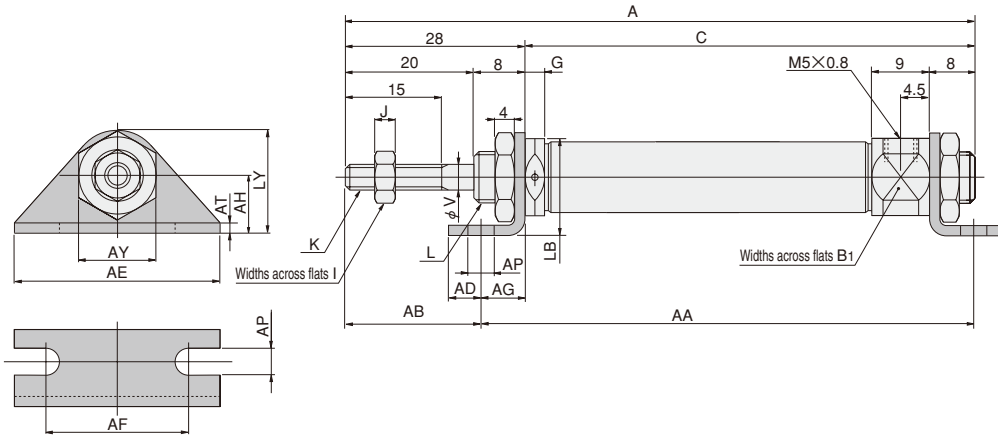

Code Stroke Bore mm [in.]	A										C										AA																
	5	10	15	20	25	30	35	40	45	50	55	60	5	10	15	20	25	30	35	40	45	50	55	60	5	10	15	20	25	30	35	40	45	50	55	60	
10 [0.394]	82	87	92	102	107	112	127	132	137	142	147	152	54	59	64	74	79	84	89.5	99	104	109	114	119	124	60	65	70	80	85	90	105	110	115	120	125	130
16 [0.630]	87.5	92.5	97.5	107.5	112.5	117.5	132.5	137.5	142.5	147.5	152.5	157.5	59.5	64.5	69.5	79.5	84.5	89.5	104.5	109.5	114.5	119.5	124.5	129.5	69.5	74.5	79.5	89.5	94.5	99.5	114.5	119.5	124.5	129.5	134.5	139.5	

Code Bore mm [in.]	B <sub>1</sub>	G	I	J	K	L	V	AB	AD	AE	AF	AG	AH	AP	AT	AY	LB	LY
10 [0.394]	12	3	7	3.2	M4×0.7	M8×1	4	21	5	32	22.2	7	9	4.2	1.6	12	15	16
16 [0.630]	17	6.5	8	4	M5×0.8	M10×1	5	19	6	42	29.2	9	14	5.2	2.3	14	22.5	24

Flange type PBSA  Bore size  × Stroke  -3

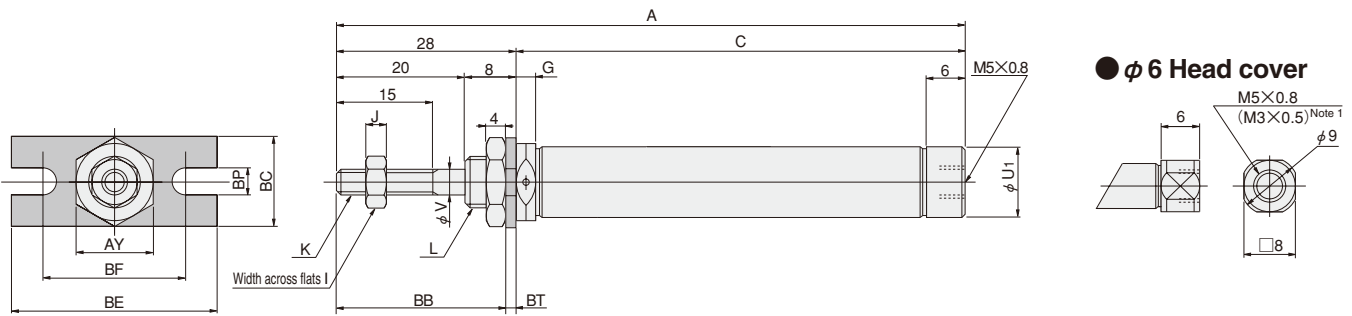

Lateral piping (-A)  
PBSA  Bore size  × Stroke  -A-3

Lateral piping with mounting thread (-M)  
PBSA  Bore size  × Stroke  -M-3

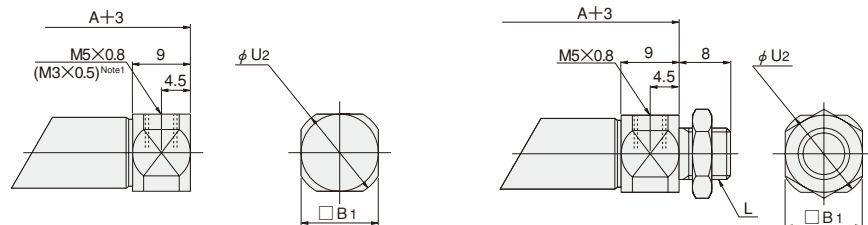

Code Stroke Bore mm [in.]	A										C													
	5	10	15	20	25	30	35	40	45	50	55	60	5	10	15	20	25	30	35	40	45	50	55	60
6 [0.236]	72	77	82	92	97	102	122	127	132	137	142	147	44	49	54	64	69	74	94	99	104	109	114	119
10 [0.394]	71	76	81	91	96	101	116	121	126	131	136	141	43	48	53	63	68	73	88	93	98	103	108	113
16 [0.630]	76.5	81.5	86.5	96.5	101.5	106.5	121.5	126.5	131.5	136.5	141.5	146.5	48.5	53.5	58.5	68.5	73.5	78.5	93.5	98.5	103.5	108.5	113.5	118.5

  

Code Bore mm [in.]	B <sub>1</sub>	G	I	J	K	L	U <sub>1</sub>	U <sub>2</sub>	V	AY	BB	BC	BE	BF	BP	BT
6 [0.236]	8	4.5	5.5	2.4	M3×0.5	M6×1	—	10.8	3	10	26.4	14	32	22.2	4.2	1.6
10 [0.394]	12	3	7	3.2	M4×0.7	M8×1	11	14	4	12	26.4	14	32	22.2	4.2	1.6
16 [0.630]	17	6.5	8	4	M5×0.8	M10×1	17	19	5	14	25.7	20	42	29.2	5.2	2.3

Notes: 1. For bore size  $\phi$  6 only.  
2. Not available for bore size  $\phi$  6.

# Dimensions of Single Acting Push Type (mm)

● Clevis mounting type PBSA  Bore size  ×  Stroke  -7

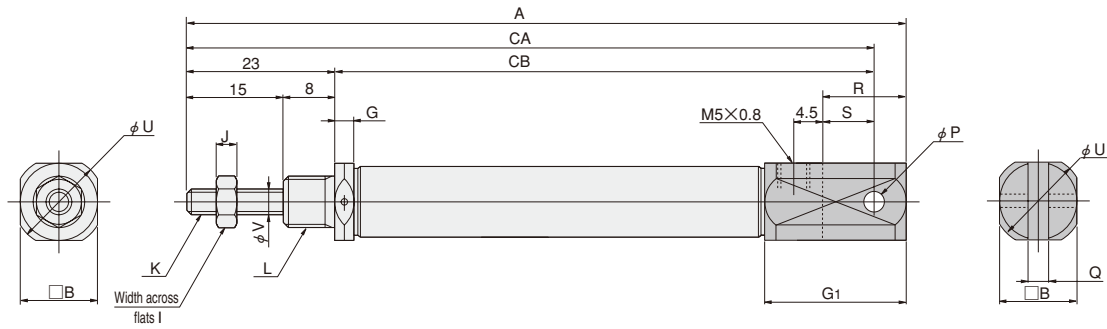

Code	A												CA												CB											
	5	10	15	20	25	30	35	40	45	50	55	60	5	10	15	20	25	30	35	40	45	50	55	60	5	10	15	20	25	30	35	40	45	50	55	60
<b>10 [0.394]</b>	82	87	92	102	107	112	127	132	137	142	147	152	77	82	87	97	102	107	122	127	132	137	142	147	54	59	64	74	79	84	99	104	109	114	119	124
<b>16 [0.630]</b>	92.5	97.5	102.5	112.5	117.5	122.5	137.5	142.5	147.5	152.5	157.5	162.5	84.5	89.5	94.5	104.5	109.5	114.5	129.5	134.5	139.5	144.5	149.5	154.5	61.5	66.5	71.5	81.5	86.5	91.5	106.5	111.5	116.5	121.5	126.5	131.5

Code	B	G	G <sub>1</sub>	I	J	K	L	P	Q	R	S	U	V
<b>10 [0.394]</b>	12	3	22	7	3.2	M4×0.7	M8×1	3.2 <sup>+0.09</sup> / <sub>+0.06</sub>	3.2 <sup>+0.2</sup> / <sub>+0.1</sub>	13	8	14	4
<b>16 [0.630]</b>	17	6.5	27	8	4	M5×0.8	M10×1	5 <sup>+0.09</sup> / <sub>+0.06</sub>	6.5 <sup>+0.2</sup> / <sub>+0.1</sub>	18	10	19	5

# Dimensions of Single Acting Pull Type (mm)

● Basic type PBTA  Bore size  ×  Stroke

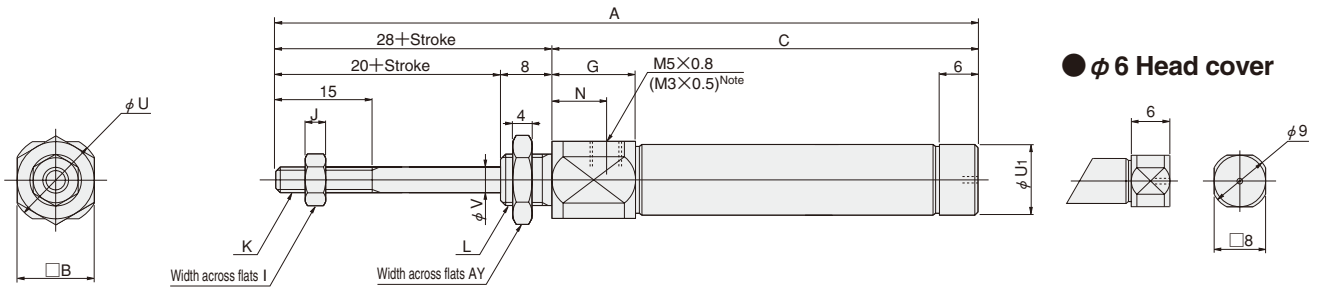

PEN CYLINDERS

Code Stroke Bore mm [in.]	A						C					
	5	10	15	20	25	30	5	10	15	20	25	30
<b>6 [0.236]</b>	87	97	107	122	132	142	54	59	64	74	79	84
<b>10 [0.394]</b>	86	96	106	121	131	141	53	58	63	73	78	83
<b>16 [0.630]</b>	86.5	96.5	106.5	121.5	131.5	141.5	53.5	58.5	63.5	73.5	78.5	83.5

Bore mm [in.]	Code	B	G	I	J	K	L	N	U	U <sub>1</sub>	V	AY
<b>6 [0.236]</b>		12	14.5	5.5	2.4	M3×0.5	M6×1	10	14	—	3	10
<b>10 [0.394]</b>		12	13	7	3.2	M4×0.7	M8×1	8.5	14	11	4	12
<b>16 [0.630]</b>		17	11.5	8	4	M5×0.8	M10×1	7	19	17	5	14

Note: For bore size φ 6 only.

● Single foot type PBTA  Bore size  ×  Stroke  -1A

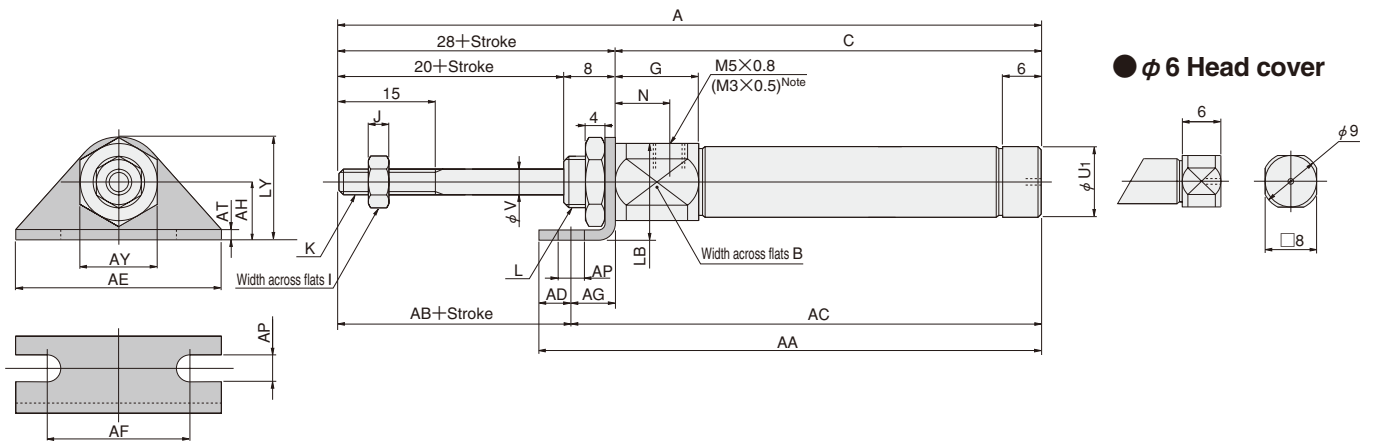

Code Stroke Bore mm [in.]	A						C						AA						AC					
	5	10	15	20	25	30	5	10	15	20	25	30	5	10	15	20	25	30	5	10	15	20	25	30
<b>6 [0.236]</b>	87	97	107	122	132	142	54	59	64	74	79	84	66	71	76	86	91	96	61	66	71	81	86	91
<b>10 [0.394]</b>	86	96	106	121	131	141	53	58	63	73	78	83	65	70	75	85	90	95	60	65	70	80	85	90
<b>16 [0.630]</b>	86.5	96.5	106.5	121.5	131.5	141.5	53.5	58.5	63.5	73.5	78.5	83.5	68.5	73.5	78.5	88.5	93.5	98.5	62.5	67.5	72.5	82.5	87.5	92.5

Bore mm [in.]	Code	B	G	I	J	K	L	N	U <sub>1</sub>	V	AB	AD	AE	AF	AG	AH	AP	AT	AY	LB	LY
<b>6 [0.236]</b>		12	14.5	5.5	2.4	M3×0.5	M6×1	10	—	3	21	5	32	22.2	7	9	4.2	1.6	10	15	16
<b>10 [0.394]</b>		12	13	7	3.2	M4×0.7	M8×1	8.5	11	4	21	5	32	22.2	7	9	4.2	1.6	12	15	16
<b>16 [0.630]</b>		17	11.5	8	4	M5×0.8	M10×1	7	17	5	19	6	42	29.2	9	14	5.2	2.3	14	22.5	24

Note: For bore size φ 6 only.

# Dimensions of Single Acting Pull Type (mm)

● Flange type PBTA  Bore size  × Stroke  -3

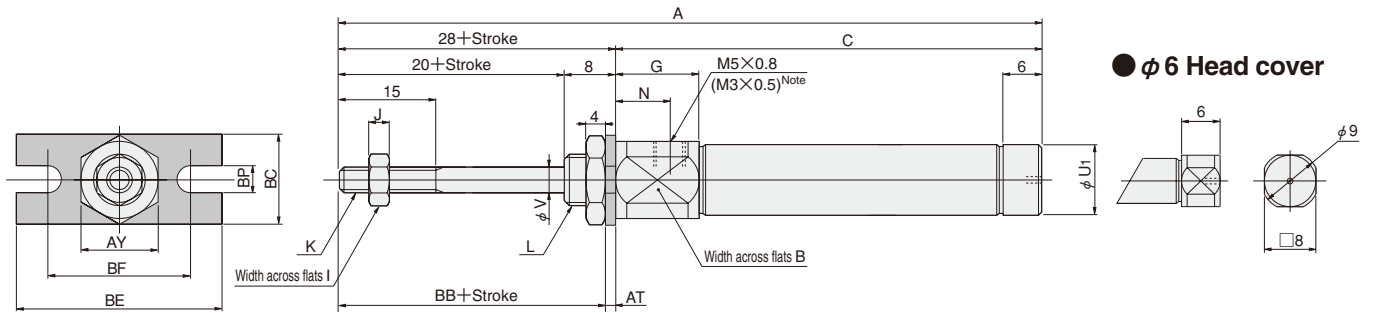

Code Stroke Bore mm [in.]	A						C					
	5	10	15	20	25	30	5	10	15	20	25	30
<b>6 [0.236]</b>	87	97	107	122	132	142	54	59	64	74	79	84
<b>10 [0.394]</b>	86	96	106	121	131	141	53	58	63	73	78	83
<b>16 [0.630]</b>	86.5	96.5	106.5	121.5	131.5	141.5	53.5	58.5	63.5	73.5	78.5	83.5

Code Stroke Bore mm [in.]	B	G	I	J	K	L	N	U <sub>1</sub>	V	AT	AY	BB	BC	BE	BF	BP
<b>6 [0.236]</b>	12	14.5	5.5	2.4	M3×0.5	M6×1	10	—	3	1.6	10	26.4	14	32	22.2	4.2
<b>10 [0.394]</b>	12	13	7	3.2	M4×0.7	M8×1	8.5	11	4	1.6	12	26.4	14	32	22.2	4.2
<b>16 [0.630]</b>	17	11.5	8	4	M5×0.8	M10×1	7	17	5	2.3	14	25.7	20	42	29.2	5.2

Note: For bore size  $\phi$  6 only.

● Clevis mounting type PBTA  Bore size  × Stroke  -7

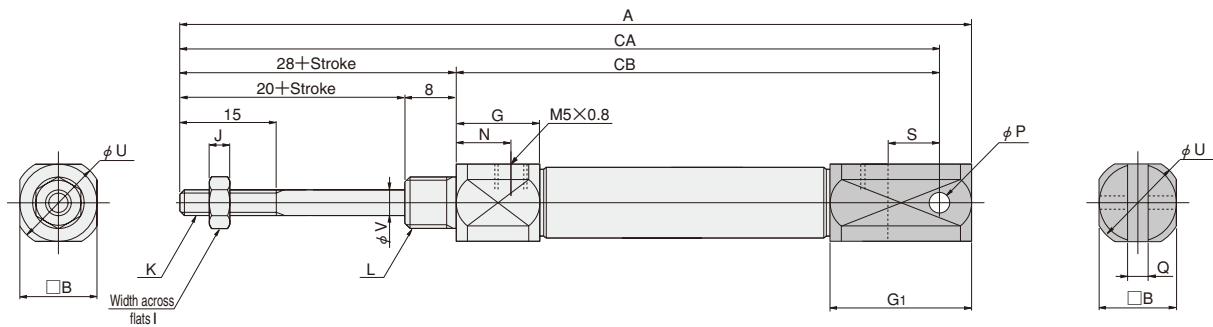

Code Stroke Bore mm [in.]	A						CA						CB					
	5	10	15	20	25	30	5	10	15	20	25	30	5	10	15	20	25	30
<b>10 [0.394]</b>	102	112	122	137	147	157	97	107	117	132	142	152	64	69	74	84	89	94
<b>16 [0.630]</b>	107.5	117.5	127.5	142.5	152.5	162.5	99.5	109.5	119.5	134.5	144.5	154.5	66.5	71.5	76.5	86.5	91.5	96.5

Code Stroke Bore mm [in.]	B	G	G <sub>1</sub>	I	J	K	L	N	P	Q	S	U	V
<b>10 [0.394]</b>	12	13	22	7	3.2	M4×0.7	M8×1	8.5	3.2 <sup>+0.09</sup> <sub>+0.06</sub>	3.2 <sup>+0.2</sup> <sub>+0.1</sub>	8	14	4
<b>16 [0.630]</b>	17	11.5	27	8	4	M5×0.8	M10×1	7	5 <sup>+0.09</sup> <sub>+0.06</sub>	6.5 <sup>+0.2</sup> <sub>+0.1</sub>	10	19	5



# PEN CYLINDERS

φ 2.5, φ 4 Single Acting Push Type



## Symbol

### ● Single acting push type

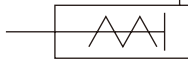

## Specifications

Item	Bore size mm [in.]	2.5 [0.098]	4 [0.157]
Operation type		Single acting push type	
Media		Air	
Mounting type		Basic type	
Operating pressure range	MPa [psi.]	0.34 ~ 0.7 [49 ~ 102]	
Proof pressure	MPa [psi.]	1.05 [152]	
Operating temperature range	°C [°F]	0 ~ 60 [32 ~ 140]	
Operating speed range	mm/s [in./sec.]	50 ~ 300 [2.0 ~ 11.8] (In applications with high load ratio or high speed, use externally mounted stoppers.)	
Cushion		None	
Lubrication		Not required	
Minimum operating pressure	MPa [psi.]	0.34 [49]	
Port size		φ 4 × φ 2.5 Barb fitting for nylon and urethane tubes is equipped with the head cover.	

Remark: Cylinders with bore size φ 2.5 are sold in packs of 5.

## Order Code

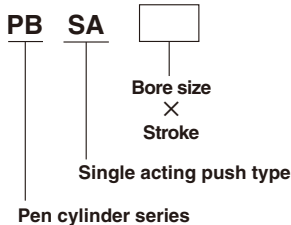

## Inner Construction (cannot be disassembled)

### ● Single acting push type

φ 2.5, φ 4

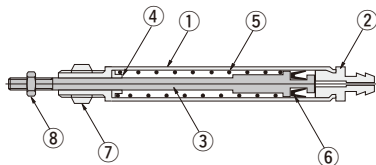

## Major Parts and Materials

No.	Parts	Materials
①	Rod cover	Brass (nickel plated)
②	Head cover	Brass (nickel plated)
③	Piston rod	Stainless steel
④	Spring holder	Stainless steel
⑤	Spring	Steel
⑥	Piston seal	Synthetic rubber (NBR)
⑦	Mounting nut	Brass (nickel plated)
⑧	Rod end nut <sup>Note</sup>	Brass (nickel plated)

Note: For bore size φ 4 only. Not available for bore size φ 2.5.

## Bore Size and Stroke

Operation type	Bore size	Standard strokes <sup>Note</sup>	Maximum available stroke	Stroke tolerance
				mm [in.]
Single acting push type	2.5	5, 10	10	+1.2 [+0.047] -0.2 [-0.008]
	4	5, 10, 15, 20	20	

Note: Because collars are used for non-standard strokes, use the figures for the length one size up from the non-standard stroke.

## Single Acting Type Spring Return Force

Bore size mm [in.]	Spring return force				End of stroke
	5St	10St	15St	20St	
2.5 [0.098]	0.6 [0.13]	0.6 [0.13]	—	—	1.2 [0.27]
4 [0.157]	1.5 [0.34]	1.5 [0.34]	1.5 [0.34]	1.5 [0.34]	2.8 [0.63]

## Mass

Bore size mm [in.]	Stroke mm			
	5	10	15	20
2.5 [0.098]	1.5 [0.053]	1.9 [0.067]	—	—
4 [0.157]	3.4 [0.120]	4.4 [0.155]	5.2 [0.183]	6.1 [0.215]

Remark: Includes a mounting nut and rod end nut (φ 4 only).

## Dimensions of Single Acting Push Type (mm)

### ● Basic type φ 2.5 PBSA2.5 × Stroke

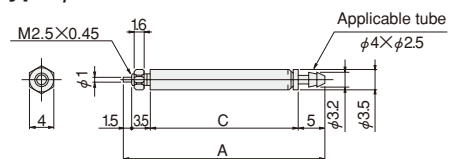

### ● Basic type φ 4 PBSA4 × Stroke

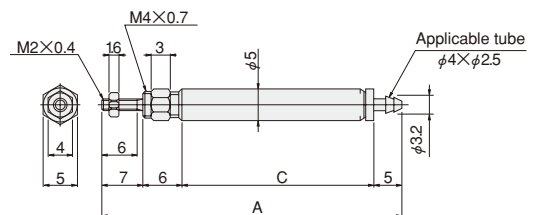

Bore mm [in.]	Code	A				C			
		5	10	15	20	5	10	15	20
2.5 [0.098]		26.5	35.5	—	—	16.5	25.5	—	—
4 [0.157]		37	46	55	64	19	28	37	46

Note: Because collars are used for non-standard strokes, use the figures for the length one size up from the non-standard stroke.

# PEN CYLINDERS

## Non-rotating Cylinders

### Symbols

#### ● Non-rotating double acting type

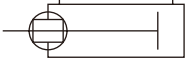

#### ● Non-rotating single acting push type



#### ● Non-rotating single acting pull type

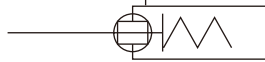

### Specifications

Item	Bore size mm [in.]	10 [0.394]	16 [0.630]
Operation type		Double acting type, Single acting push type, Single acting pull type	
Mounting type		Basic type, Foot type, Flange type, Clevis type	
Media		Air	
Operating pressure range MPa [psi.]		0.1 ~ 0.7 [15 ~ 102] <sup>Note1</sup>	
Proof pressure MPa [psi.]		1.05 [152]	
Operating temperature range °C [°F]		0 ~ 70 [32 ~ 158]	
Operating speed range mm/s [in./sec.]		50 ~ 500 [2.0 ~ 19.7] <sup>Note2</sup>	
Cushion		Fixed type (rubber bumper)	
Lubrication		Not required	
Port size		M5 × 0.8	
Non-rotating accuracy		± 2°	

Notes: 1. Single acting push type: 0.15 ~ 0.7 [22 ~ 102]  
 Single acting pull type: 0.2 ~ 0.7 [29 ~ 102]  
 2. Single acting push type and single acting pull type: 50 ~ 300 [2.0 ~ 11.8]

### Mounting Type

Mounting type	Name	Remark
1A, 1	Single foot type, double foot type	Included at shipping
3	Flange type	Included at shipping
7	Clevis type (with pin)	Assembled and shipped
7-7C	Clevis type with supporting bracket (with pin)	Supporting bracket included at shipping

### Order Codes

**PB** [ ] [ ] **10 × 30** - [ ] - [ ] - [ ] - [ ] - [ ] - [ ] - [ ]

**Bore size × Stroke**

**Cylinder specification**  
 Blank — Standard cylinder  
 S — Cylinder with magnet

**Operation type**  
 DAL — Non-rotating double acting type  
 SAL — Non-rotating single acting push type  
 TAL — Non-rotating single acting pull type

**Pen cylinder series**

**Head cover piping specification**  
 Blank — Axial direction piping  
 A — Lateral piping※  
 M — Lateral piping with mounting thread※  
 ※ (-A, -M correspond only to double acting type and single acting push type. Not available for clevis mounting type.)

**Rod end accessory**  
 Blank — No rod end accessory  
 I — With I type knuckle  
 Y — With Y type knuckle (with pin)  
 ● As for the cylinder joints and the cylinder rod ends, order separately.

**Mounting type (Included at shipping other than clevis mounting type)**  
 Blank — Basic type  
 1 — Double foot mounting type (Mountable only on head cover -M specification)  
 1A — Single foot mounting type  
 3 — Flange mounting type  
 7 — Clevis mounting type (With pin, and non-rotating double acting type only)  
 7-7C — Clevis mounting type with pin and clevis supporting bracket (Non-rotating double acting type only)

**Number of sensor switches**  
 1 — With 1 sensor switch  
 2 — With 2 sensor switches  
 3 — With 3 sensor switches  
 ⋮  
 ⋮

**Lead wire length**  
 A — 1000mm [39in.]  
 B — 3000mm [118in.]

**Sensor switch**  
 Blank — No sensor switch  
 ZC253 — 3-lead wire, solid state type  
 ZC230 — 2-lead wire, solid state type  
 ZC201 — 2-lead wire, reed switch type  
 ZC205 — 2-lead wire, reed switch type  
 ● For details, see p.1544.



### Bore Size and Stroke

● Double acting type		mm [in.]	
Bore size	Standard strokes <sup>Note</sup>	Maximum available stroke	Stroke tolerance
10	5, 10, 15, 30, 45, 60	100	+1.5 0 0
16	5, 10, 15, 30, 45, 60	150	[+0.059] 0

● Single acting type		mm [in.]		
Operation type	Bore size	Standard strokes <sup>Note</sup>	Maximum available stroke	Stroke tolerance
Single acting push type	10	5, 10, 15, 30, 45, 60	60	+1.5 0 0
	16			
Single acting pull type	10	5, 10, 15, 30	30	+1.5 0 0
	16			

Note: For non-standard strokes:  
 Collars are added to standard stroke cylinders of the next size up.

### Single Acting Type Spring Return Force

Bore size mm	Spring return force						End of stroke
	5St	10St	15St	30St	45St	60St	
10	5.1 [1.15]	4.4 [0.99]	3.7 [0.83]	3.7 [0.83]	4.2 [0.94]	3.7 [0.83]	5.9 [1.33]
16	8.5 [1.91]	7.3 [1.64]	6.1 [1.37]	6.1 [1.37]	7.0 [1.57]	6.1 [1.37]	9.8 [2.20]

# Mass

g [oz.]

Operation type	Mounting type	Bore size mm	Stroke mm						Additional mass						
									Mounting type			Cylinder with magnet	Sensor switch (1 pc.) <sup>Note 2</sup>	Lateral piping	
			5	10	15	30	45	60	Single foot	Flange	Clevis <sup>Note 1</sup>			-A	-M
Double acting type	Basic type	10	25 [0.88]	26 [0.92]	27 [0.95]	30 [1.06]	34 [1.20]	37 [1.31]	18 [0.63]	12 [0.42]	—	1 [0.04]	A : 20 [0.71] B : 50 [1.76]	2 [0.07]	6 [0.21]
		16	45 [1.59]	47 [1.66]	49 [1.73]	55 [1.94]	60 [2.12]	65 [2.29]	18 [0.63]	12 [0.42]	—	2 [0.07]		3 [0.11]	8 [0.28]
	Clevis mounting type	10	29 [1.02]	30 [1.06]	31 [1.09]	34 [1.20]	38 [1.34]	41 [1.45]	—	—	32 [1.13]	1 [0.04]		—	—
		16	56 [1.98]	58 [2.05]	60 [2.12]	66 [2.33]	71 [2.50]	76 [2.68]	—	—	45 [1.59]	2 [0.07]		—	—
Single acting push type	Basic type	10	23 [0.81]	24 [0.85]	25 [0.88]	30 [1.06]	38 [1.34]	41 [1.45]	18 [0.63]	12 [0.42]	—	1 [0.04]	A : 20 [0.71] B : 50 [1.76]	2 [0.07]	6 [0.21]
		16	45 [1.59]	47 [1.66]	49 [1.73]	58 [2.05]	73 [2.57]	78 [2.75]	18 [0.63]	12 [0.42]	—	2 [0.07]	3 [0.11]	8 [0.28]	
Single acting pull type	Basic type	10	25 [0.88]	27 [0.95]	28 [0.99]	33 [1.16]	—	—	18 [0.63]	12 [0.42]	—	1 [0.04]	A : 20 [0.71] B : 50 [1.76]	—	—
		16	48 [1.69]	50 [1.76]	51 [1.80]	61 [2.15]	—	—	18 [0.63]	12 [0.42]	—	2 [0.07]	—	—	

Remark: Includes mounting nut and rod end nut. For the mass of the double foot bracket, add double the mass of the single foot bracket listed above.

Notes: 1. With supporting bracket and pin.

2. Same for all sensor switch models (ZC253□, ZC230□, ZC201□, ZC205□).

## Inner Construction (cannot be disassembled)

### ● Double acting type

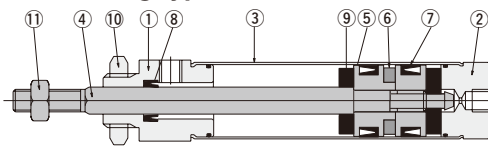

### ● Clevis mounting type (-7)

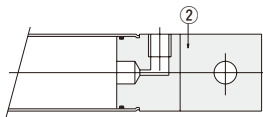

### ● Lateral piping (-A)

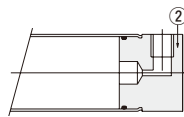

### ● Lateral piping with mounting thread (-M)

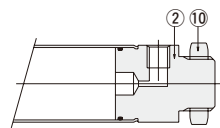

### ● Single acting push type

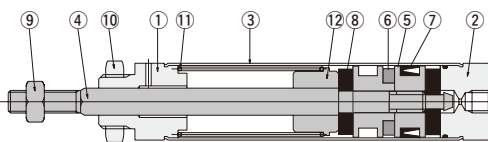

### ● Lateral piping (-A)

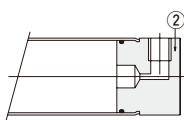

### ● Lateral piping with mounting thread (-M)

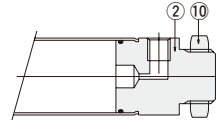

### ● Single acting pull type

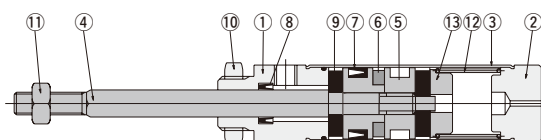

## Major Parts and Materials

No.	Parts	Materials
①	Rod cover	Aluminum alloy (nickel plated)
②	Head cover	Aluminum alloy (nickel plated)
③	Cylinder tube	Stainless steel
④	Piston rod	
⑤	Piston	Aluminum alloy
⑥	Magnet <sup>Note</sup>	Plastic magnet
⑦	Piston seal	Synthetic rubber (NBR)
⑧	Rod seal	
⑨	Bumper	
⑩	Mounting nut	Mild steel (nickel plated)
⑪	Rod end nut	

Note: For cylinders with magnets. Standard cylinders do not have a built-in magnet for the sensor switch.

No.	Parts	Materials
①	Rod cover	Aluminum alloy (nickel plated)
②	Head cover	Aluminum alloy (nickel plated)
③	Cylinder tube	Stainless steel
④	Piston rod	
⑤	Piston	Aluminum alloy
⑥	Magnet <sup>Note</sup>	Plastic magnet
⑦	Piston seal	Synthetic rubber (NBR)
⑧	Bumper	
⑨	Rod end nut	Mild steel (nickel plated)
⑩	Mounting nut	
⑪	Spring	Steel
⑫	Collar	Aluminum alloy

Note: For cylinders with magnets. Standard cylinders do not have a built-in magnet for the sensor switch.

No.	Parts	Materials
①	Rod cover	Aluminum alloy (nickel plated)
②	Head cover	Aluminum alloy (nickel plated)
③	Cylinder tube	Stainless steel
④	Piston rod	
⑤	Piston	Aluminum alloy
⑥	Magnet <sup>Note1</sup>	Plastic magnet
⑦	Piston seal	Synthetic rubber (NBR)
⑧	Rod seal	
⑨	Bumper <sup>Note2</sup>	
⑩	Mounting nut	Mild steel (nickel plated)
⑪	Rod end nut	
⑫	Spring	Steel
⑬	Collar	Aluminum alloy

Note: For cylinders with magnets. Standard cylinders do not have a built-in magnet for the sensor switch.

# Dimensions of Non-rotating Double Acting Type (mm)

## ● Basic type PBDAL Bore size × Stroke

Cross section of the rod

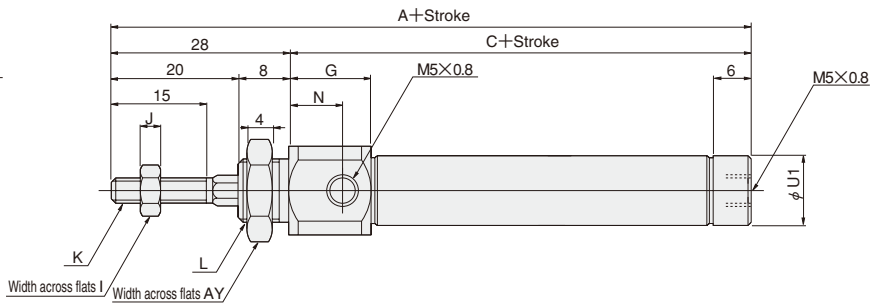
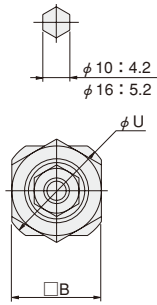

## ● Lateral piping (-A) PBDAL Bore size × Stroke -A

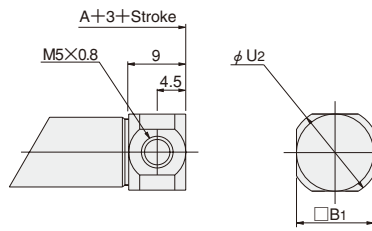

## ● Lateral piping with mounting thread (-M) PBDAL Bore size × Stroke -M

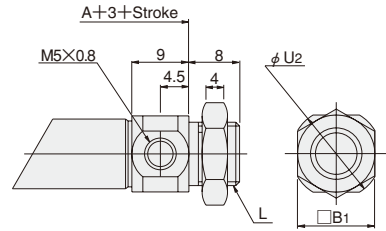

Bore mm [in.]	Code	A	B	B <sub>1</sub>	C	I	J	K	L	N	G	AY	U	U <sub>1</sub>	U <sub>2</sub>
10 [0.394]		71	14	12	43	7	3.2	M4×0.7	M10×1	8.5	13	14	17	11	14
16 [0.630]		71.5	17	17	43.5	8	4	M5×0.8	M12×1	7	11.5	17	19	17	19

## ● Clevis mounting type PBDAL Bore size × Stroke -7

Cross section of the rod

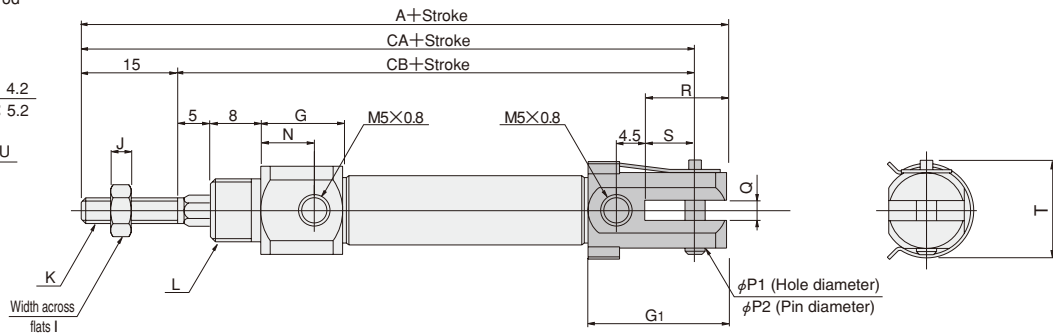
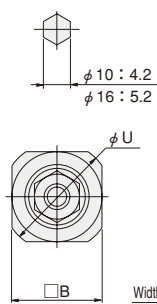

Bore mm [in.]	Code	A	B	G	G <sub>1</sub>	I	J	K	L	N	P <sub>1</sub>	P <sub>2</sub>	Q	R	S	T	U	CA	CB
10 [0.394]		87	14	13	22	7	3.2	M4×0.7	M10×1	8.5	3.2 <sup>+0.09</sup> <sub>+0.06</sub>	3.2 <sup>+0.03</sup> <sub>0</sub>	3.2 <sup>+0.2</sup> <sub>+0.1</sub>	13	8	15.5	17	82	67
16 [0.630]		92.5	17	11.5	27	8	4	M5×0.8	M12×1	7	5 <sup>+0.09</sup> <sub>+0.06</sub>	5 <sup>+0.03</sup> <sub>0</sub>	6.5 <sup>+0.2</sup> <sub>+0.1</sub>	18	10	21	19	84.5	69.5



## Dimensions of Non-rotating Single Acting Pull Type (mm)

● Basic type PBTAL  Bore size  ×  Stroke

Cross section of the rod

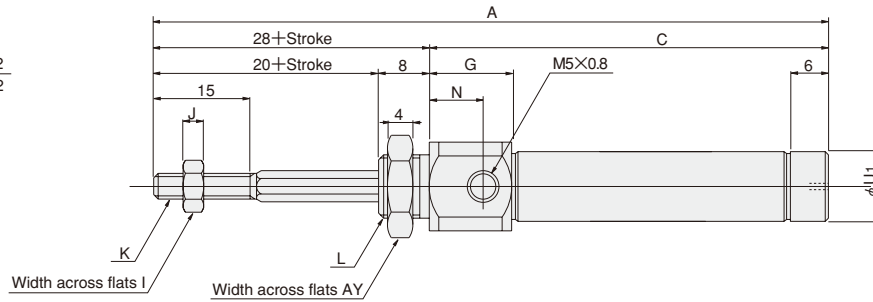
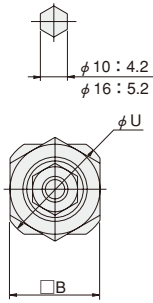

Code Stroke Bore mm [in.]	A						C					
	5	10	15	20	25	30	5	10	15	20	25	30
<b>10 [0.394]</b>	86	96	106	121	131	141	53	58	63	73	78	83
<b>16 [0.630]</b>	86.5	96.5	106.5	121.5	131.5	141.5	53.5	58.5	63.5	73.5	78.5	83.5

Code Bore mm [in.]	B	G	I	J	K	L	N	U	U <sub>1</sub>	AY
<b>10 [0.394]</b>	14	13	7	3.2	M4×0.7	M10×1	8.5	17	11	14
<b>16 [0.630]</b>	17	11.5	8	4	M5×0.8	M12×1	7	19	17	17

## Handling Instructions and Precautions (Non-rotating Cylinders)

1. To mount the cylinder body in place, first secure the rod cover, and then tighten the mounting nuts to the recommended torque shown below.

Bore size mm [in.]	Recommended tightening torque N·cm [in·lbf]
<b>10 [0.394]</b>	600 [53]
<b>16 [0.630]</b>	1200 [106]

2. For non-rotating cylinders, avoid applying rotation torque to the piston rod. The bushing section will become deformed and non-rotating accuracy will deteriorate.
3. For single acting cylinders, avoid applying loads while returning by spring force. Spring inside the cylinder could not make return the carrying work to the end of stroke.

# PEN CYLINDERS

## Double Rod Cylinders

### Symbol

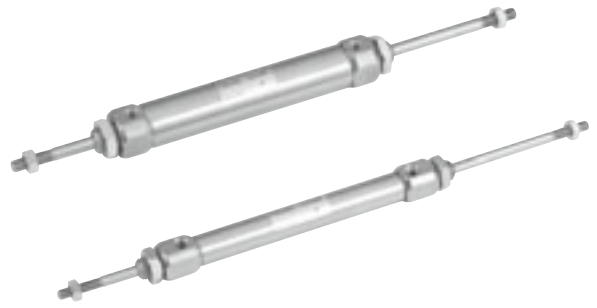

### Specifications

Item	Bore size mm [in.]	10 [0.394]	16 [0.630]
Operation type		Double acting type	
Mounting type		Basic type, Foot type, Flange type	
Media		Air	
Operating pressure range MPa [psi.]		0.1 ~ 0.7 [15 ~ 102]	
Proof pressure MPa [psi.]		1.05 [152]	
Operating temperature range °C [°F]		0 ~ 70 [32 ~ 158]	
Operating speed range mm/s [in./sec.]		50 ~ 750 [2.0 ~ 29.5]	
Cushion		Fixed type (Rubber bumper)	
Lubrication		Not required	
Port size		M5 × 0.8	

### Bore Size and Stroke

Bore size	Standard strokes <sup>Note</sup>	Maximum available stroke
10	5, 10, 15, 20, 25, 30, 35, 40, 45, 50, 55, 60	60
16	5, 10, 15, 20, 25, 30, 35, 40, 45, 50, 55, 60, 75, 100	100

Note: For non-standard strokes:  
 For strokes divisible by 5, cylinder tube cutting is used.  
 For strokes not divisible by 5, collar packed to the next size up stroke of cylinder.

### Mounting Type

Mounting type	Name	Remark
1	Double foot type	Included at shipping
1A	Single foot type <sup>Note</sup>	Included at shipping
3	Flange type	Included at shipping

Note: When the stroke exceeds 60mm, use the double foot type for the foot bracket.

### Order Codes

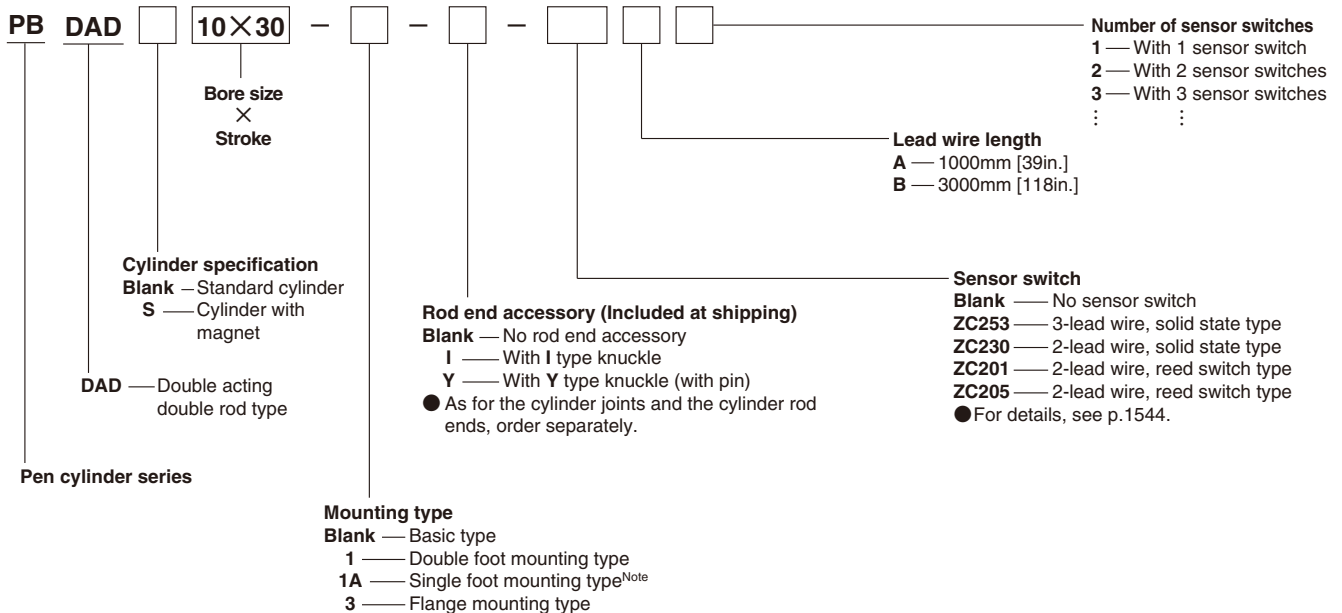

## Inner Construction (cannot be disassembled)

### ● Double acting type

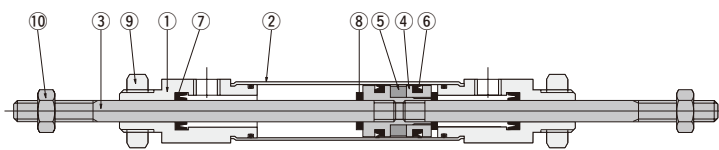

## Major Parts and Materials

No.	Parts	Materials
①	Rod cover	Aluminum alloy (nickel plated)
②	Cylinder tube	Stainless steel
③	Piston rod	
④	Piston	Aluminum alloy
⑤	Magnet <sup>Note</sup>	Plastic magnet
⑥	Piston seal	Synthetic rubber (NBR)
⑦	Rod seal	
⑧	Bumper	Mild steel (nickel plated)
⑨	Mounting nut	
⑩	Rod end nut	

Note: For cylinders with magnets. Standard cylinders do not have a built-in magnet for the sensor switch.

## Mass

Bore mm [in.]	Stroke mm														Additional mass							
															Mounting bracket			Cylinder with magnet	Sensor switch			
	5	10	15	20	25	30	35	40	45	50	55	60	75	100	-1A	-1	-3		ZC253□	ZC230□	ZC201□	ZC205□
<b>10</b> [0.394]	32.7 [1.153]	34.4 [1.213]	36 [1.270]	37.7 [1.330]	39.4 [1.390]	41 [1.446]	42.7 [1.506]	44.4 [1.566]	46 [1.623]	47.7 [1.683]	50 [1.764]	51 [1.799]	—	—	7 [0.25]	14 [0.49]	5 [0.18]	1 [0.04]	A : 20 [0.71] B : 50 [1.76]			
<b>16</b> [0.630]	60 [2.116]	62.5 [2.205]	65 [2.293]	67.5 [2.381]	70 [2.469]	72.5 [2.557]	75 [2.646]	77.5 [2.734]	80 [2.822]	82.5 [2.910]	85 [2.998]	87.5 [3.086]	90 [3.175]	92.5 [3.263]	18 [0.63]	36 [1.27]	12 [0.42]	2 [0.07]				

Remark: Includes mounting nut and rod end nut.



# Dimensions of Double Rod Type (mm)

● Basic type PBDAD  Bore size  ×  Stroke

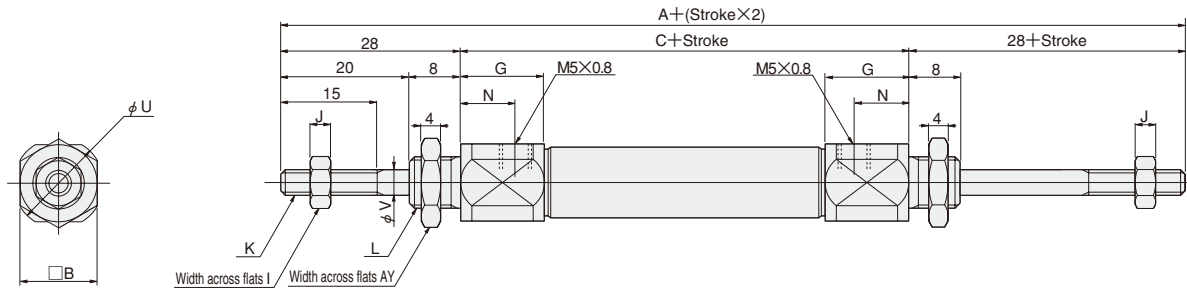

PEN CYLINDERS

Bore mm [in.]	Code	A	C	B	G	I	J	K	L	N	U	V	AY
10 [0.394]		116	60	12	13	7	3.2	M4×0.7	M8×1	8.5	14	4	12
16 [0.630]		115	59	17	11.5	8	4	M5×0.8	M10×1	7	19	5	14

● Single foot type PBDAD  Bore size  ×  Stroke -1A

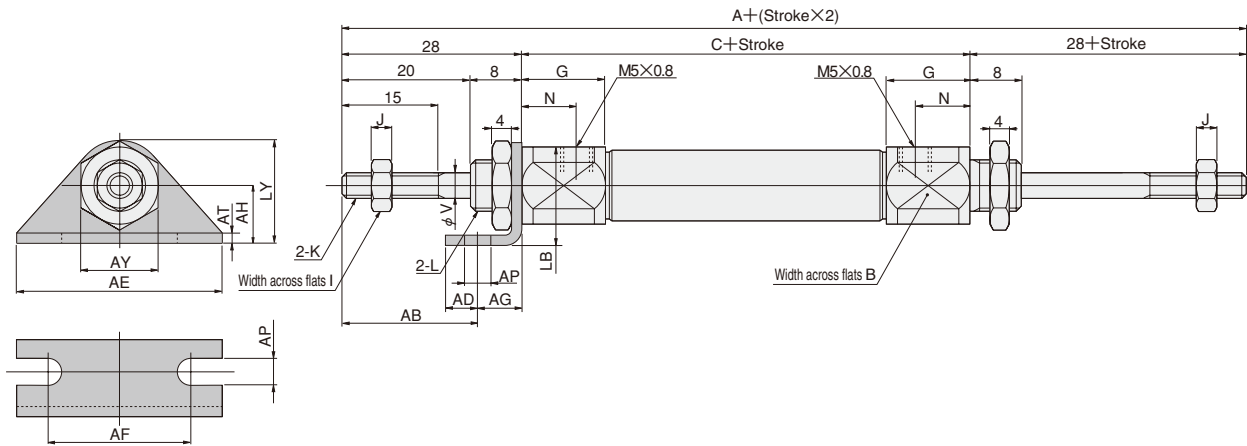

Bore mm [in.]	Code	A	C	B	G	I	J	K	L	N	V	AB	AD	AE	AF	AG	AH	AP	AT	AY	LB	LY
10 [0.394]		116	60	12	13	7	3.2	M4×0.7	M8×1	8.5	4	21	5	32	22.2	7	9	4.2	1.6	12	15	16
16 [0.630]		115	59	17	11.5	8	4	M5×0.8	M10×1	7	5	19	6	42	29.2	9	14	5.2	2.3	14	22.5	24

# Dimensions of Double Rod Type (mm)

● Double foot type PBDAD  Bore size  ×  Stroke -1

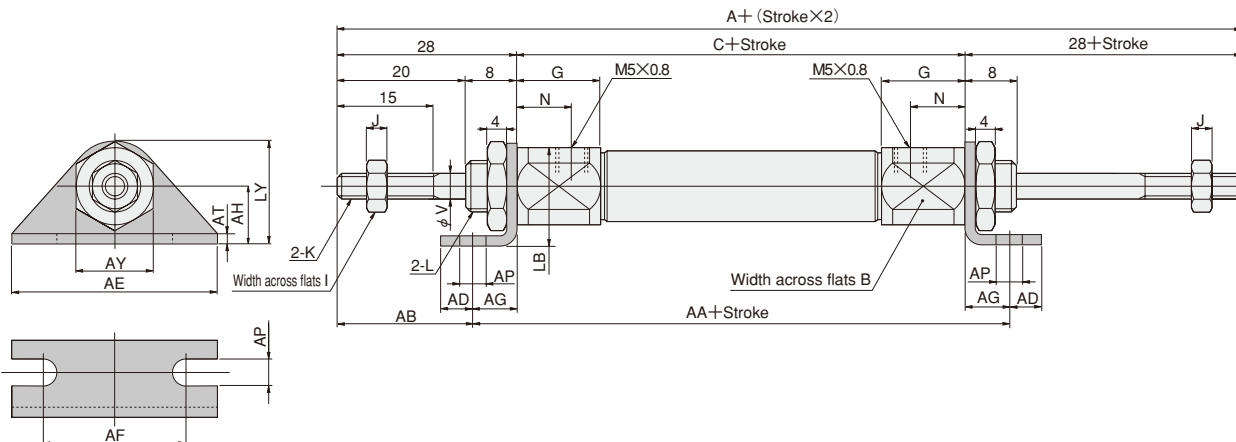

Bore mm [in.]	Code	A	C	B	G	I	J	K	L	N	V	AA	AB	AD	AE	AF	AG	AH	AP	AT	AY	LB	LY
10 [0.394]		116	60	12	13	7	3.2	M4×0.7	M8×1	8.5	4	74	21	5	32	22.2	7	9	4.2	1.6	12	15	16
16 [0.630]		115	59	17	11.5	8	4	M5×0.8	M10×1	7	5	77	19	6	42	29.2	9	14	5.2	2.3	14	22.5	24

● Flange type PBDAD  Bore size  ×  Stroke -3

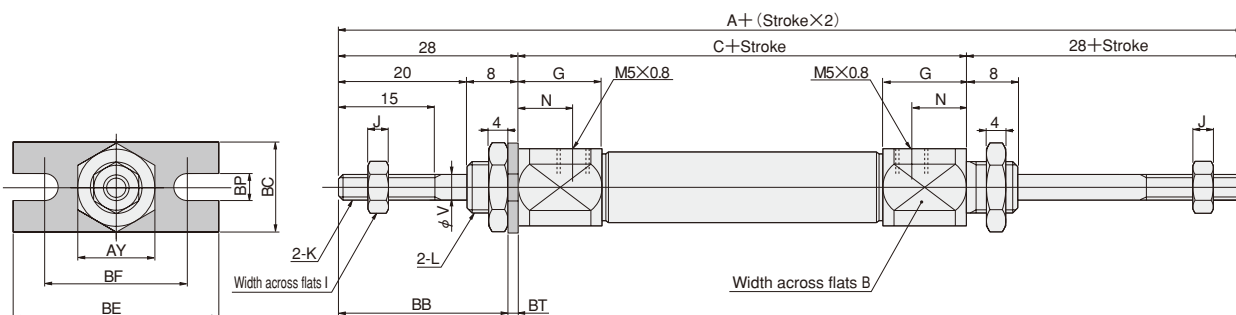

Bore mm [in.]	Code	A	C	B	G	I	J	K	L	N	V	AY	BB	BC	BE	BF	BP	BT
10 [0.394]		116	60	12	13	7	3.2	M4×0.7	M8×1	8.5	4	12	26.4	14	32	22.2	4.2	1.6
16 [0.630]		115	59	17	11.5	8	4	M5×0.8	M10×1	7	5	14	25.7	20	42	29.2	5.2	2.3

# PEN CYLINDERS

## Pull Side Stroke Adjusting Cylinders

### Symbol

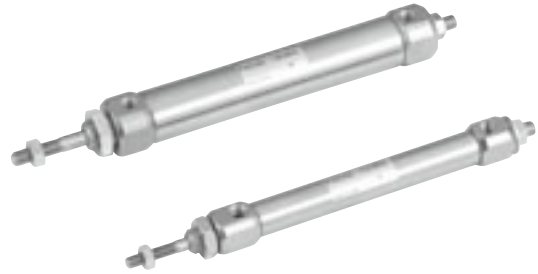
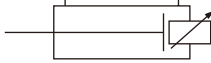

### Specifications

Item	Bore size mm [in.]	10 [0.394]	16 [0.630]
Operation type		Double acting type	
Mounting type		Basic type, Foot type, Flange type	
Media		Air	
Operating pressure range MPa [psi.]		0.08~0.7 [12~102]	0.06~0.7 [9~102]
Proof pressure MPa [psi.]		1.05 [152]	
Operating temperature range °C [°F]		0~70 [32~158]	
Operating speed range mm/s [in./sec.]		50~750 [2.0~29.5]	
Cushion		Fixed type (Rubber bumper on rod side <sup>Note</sup> )	
Lubrication		Not required	
Port size		M5×0.8	
Stroke adjusting range mm [in.]		0~-15 [0~-0.591]	

Note: No cushion on head side.

### Bore Size and Stroke

Bore size	Standard strokes <sup>Note</sup>	mm [in.]	
		Maximum available stroke	Stroke tolerance
10	15, 20, 25, 30, 35, 40, 45, 50, 55, 60	150	$\begin{matrix} +1.5 \\ 0 \\ [+0.059] \\ 0 \end{matrix}$
	75, 100, 125, 150		
16	15, 20, 25, 30, 35, 40, 45, 50, 55, 60	200	$\begin{matrix} +1.5 \\ 0 \\ [+0.059] \\ 0 \end{matrix}$
	75, 100, 125, 150, 175, 200		

Note: The non-standard stroke:

For strokes divisible by 5, cylinder tube cutting is used.

For strokes not divisible by 5, collar packed to the next size up stroke of cylinder.

### Mounting Type

Mounting type	Name	Remark
1A	Single foot type <sup>Note</sup>	Included at shipping
3	Flange type	Included at shipping

Note: When the stroke exceeds 60mm, do not use the single foot type.

### Order Codes

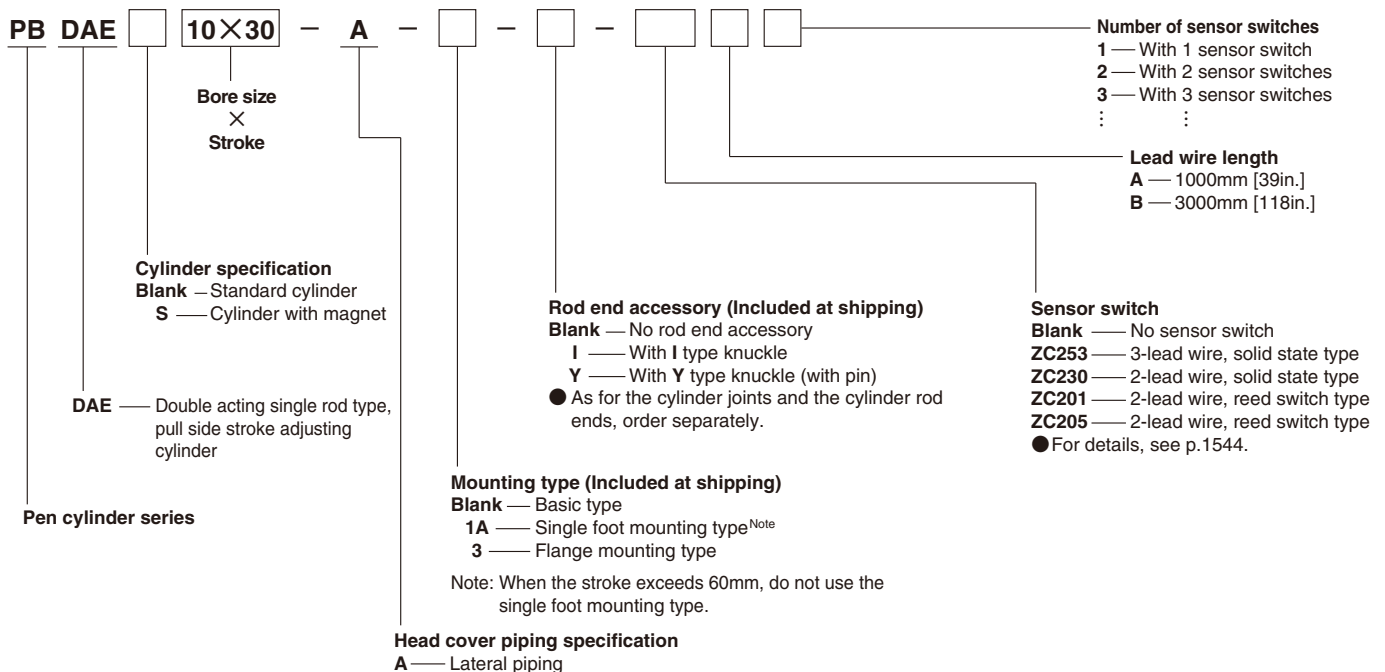

# Inner Construction (cannot be disassembled)

## ● Double acting type

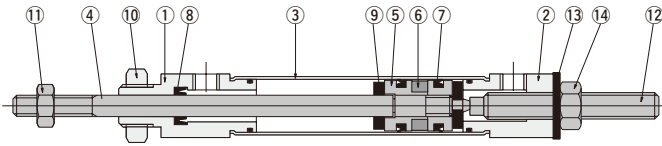

# Major Parts and Materials

No.	Parts	Materials
①	Rod cover	Aluminum alloy (nickel plated)
②	Head cover	
③	Cylinder tube	Stainless steel
④	Piston rod	
⑤	Piston	Aluminum alloy
⑥	Magnet <sup>Note</sup>	Plastic magnet
⑦	Piston seal	Synthetic rubber (NBR)
⑧	Rod seal	
⑨	Bumper	
⑩	Mounting nut	Mild steel (nickel plated)
⑪	Rod end nut	Mild steel (nickel plated)
⑫	Stroke adjusting bolt	Steel (nickel plated)
⑬	Seal washer	Mild steel + synthetic rubber (NBR)
⑭	Lock nut	Mild steel (nickel plated)

Note: For cylinders with magnets. Standard cylinders do not have a built-in magnet for the sensor switch.

# Mass

Bore mm [in.]	Stroke mm															Additional mass							
	15	20	25	30	35	40	45	50	55	60	75	100	125	150	175	200	Mounting bracket -1A    -3	Cylinder with magnet	Sensor switch				
																ZC253			ZC230	ZC201	ZC205		
<b>10 [0.394]</b>	32 [1.129]	33.2 [1.171]	34.4 [1.213]	35.5 [1.252]	36.7 [1.295]	37.9 [1.337]	39 [1.376]	40.2 [1.418]	41.4 [1.460]	42.5 [1.499]	43.7 [1.541]	44.9 [1.584]	46 [1.623]	47.2 [1.665]	—	—	7 [0.25]	5 [0.18]	1 [0.04]	A : 20 [0.71] B : 50 [1.76]			
<b>16 [0.630]</b>	52 [1.834]	53.9 [1.901]	55.7 [1.965]	57.5 [2.028]	59.4 [2.095]	61.2 [2.159]	63 [2.222]	64.9 [2.289]	66.7 [2.353]	68.5 [2.416]	70.4 [2.483]	72.2 [2.547]	74 [2.610]	75.9 [2.677]	77.7 [2.741]	79.5 [2.804]	18 [0.63]	12 [0.42]	2 [0.07]				

Remark: Includes mounting nut and rod end nut.

# Dimensions of Pull Side Stroke Adjusting Type (mm)

● Basic type PBDAE  Bore size  × Stroke

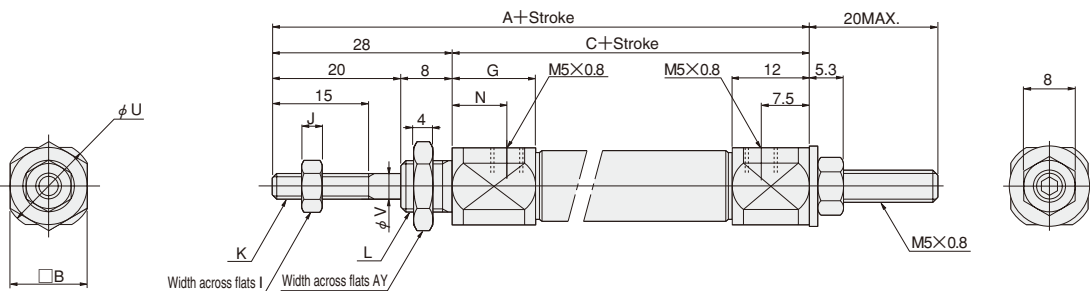

Bore mm [in.]	Code	A	C	B	G	I	J	K	L	N	U	V	AY
<b>10 [0.394]</b>		77	49	12	13	7	3.2	M4×0.7	M8×1	8.5	14	4	12
<b>16 [0.630]</b>		77.5	49.5	17	11.5	8	4	M5×0.8	M10×1	7	19	5	14

# PEN CYLINDERS

## Push Side Stroke Adjusting Cylinders

### Symbol

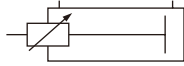

### Specifications

Item	Bore size mm [in.]	10 [0.394]	16 [0.630]
Operation type		Double acting type	
Mounting type		Basic type, Foot type, Flange type	
Media		Air	
Operating pressure range MPa [psi.]		0.1~0.7 [15~102]	
Proof pressure MPa [psi.]		1.05 [152]	
Operating temperature range °C [°F]		0~70 [32~158]	
Operating speed range mm/s [in./sec.]		50~750 [2.0~29.5]	
Cushion		Rubber bumper	
Lubrication		Not required	
Port size		M5×0.8	
Stroke adjusting range mm [in.]		0~15 [0~0.591]	

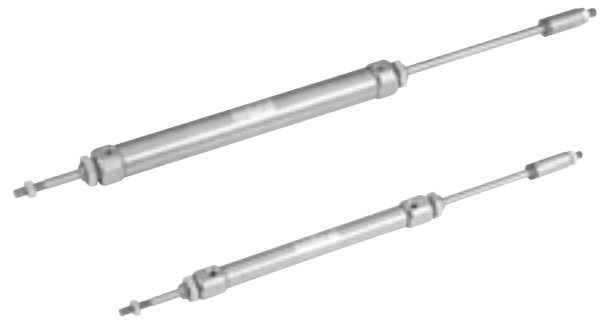

PEN CYLINDERS

### Bore Size and Stroke

Bore size	Standard strokes <sup>Note</sup>	Maximum available stroke	mm [in.]
			Stroke tolerance
10	15, 20, 25, 30, 35, 40, 45, 50, 55, 60	60	$\begin{matrix} +1.5 \\ 0 \\ [+0.059] \\ 0 \end{matrix}$
16	15, 20, 25, 30, 35, 40, 45, 50, 55, 60, 75, 100	100	$\begin{matrix} +1.5 \\ 0 \\ [+0.059] \\ 0 \end{matrix}$

Note: The non-standard stroke:  
For strokes divisible by 5, cylinder tube cutting is used.  
For strokes not divisible by 5, consult us.

### Mounting Type

Mounting type	Name	Remark
1	Double foot type	Included at shipping
1A	Single foot type <sup>Note</sup>	Included at shipping
3	Flange type	Included at shipping

Note: When the stroke exceeds 60mm, use the double foot type for the foot bracket.

### Order Codes

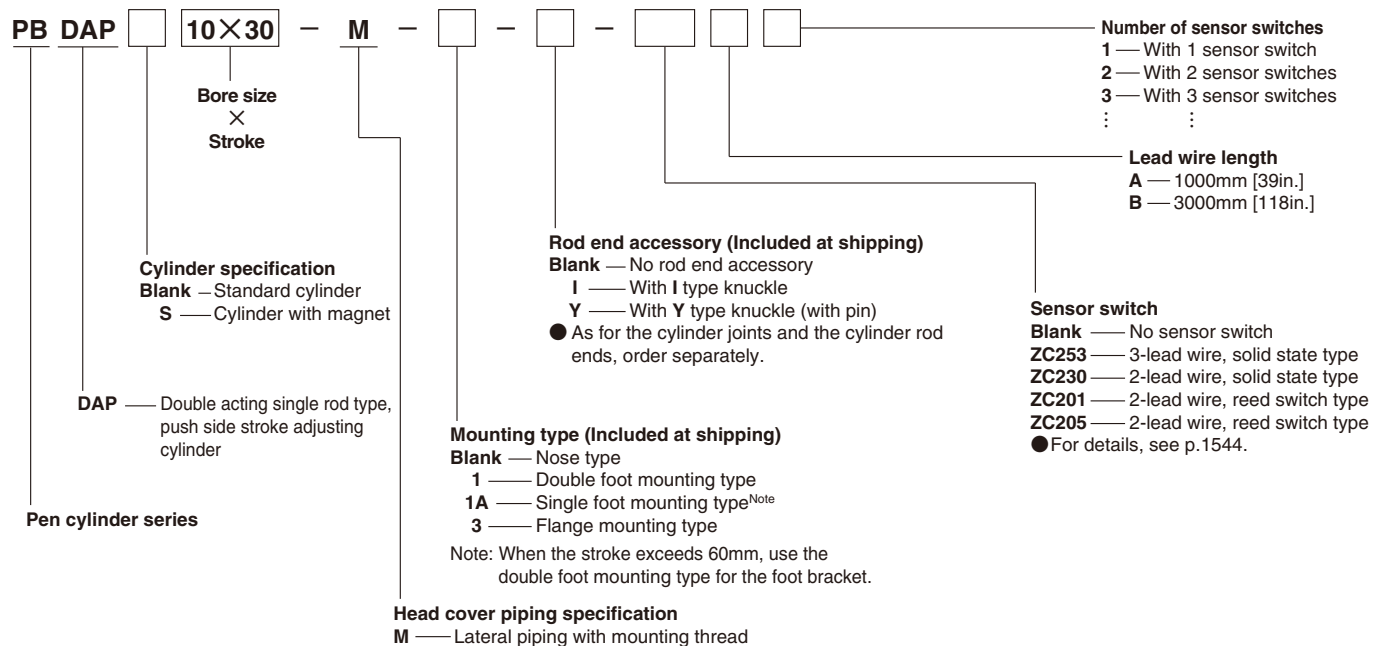

## Inner Construction (cannot be disassembled)

### ● Double acting type

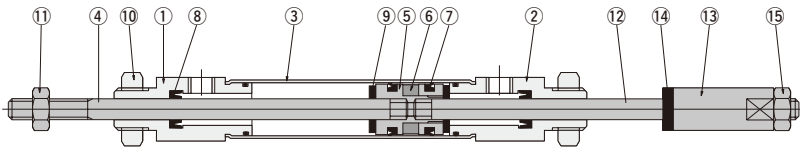

## Major Parts and Materials

No.	Parts	Materials
①	Rod cover	Aluminum alloy (nickel plated)
②	Head cover	
③	Cylinder tube	Stainless steel
④	Piston rod	
⑤	Piston	Aluminum alloy
⑥	Magnet <sup>Note</sup>	Plastic magnet
⑦	Piston seal	Synthetic rubber (NBR)
⑧	Rod seal	
⑨	Bumper	
⑩	Mounting nut	Mild steel (nickel plated)
⑪	Rod end nut	
⑫	Stroke adjusting rod	Stainless steel
⑬	Stroke adjusting knob	Aluminum alloy (nickel plated)
⑭	Bumper	Synthetic rubber (NBR)
⑮	Rock nut	Mild steel (nickel plated)

Note: For cylinders with magnets. Standard cylinders do not have a built-in magnet for the sensor switch.

## Mass

Bore mm [in.]	Stroke mm												Additional mass							
	15	20	25	30	35	40	45	50	55	60	75	100	Mounting bracket			Cylinder with magnet	Sensor switch			
	-1	-1A	-3	ZC253	ZC230	ZC201	ZC205													
<b>10 [0.394]</b>	39 [1.376]	40.7 [1.436]	42.4 [1.496]	44 [1.552]	45.7 [1.612]	47.4 [1.672]	49 [1.728]	50.7 [1.788]	52.4 [1.848]	54 [1.905]	—	—	14 [0.49]	7 [0.25]	5 [0.18]	1 [0.04]	A : 20 [0.71] B : 50 [1.76]			
<b>16 [0.630]</b>	72 [2.540]	74.5 [2.628]	77 [2.716]	79.5 [2.804]	82 [2.892]	84.5 [2.981]	87 [3.069]	89.5 [3.157]	92 [3.245]	94.5 [3.333]	97 [3.422]	99.5 [3.510]	36 [1.27]	18 [0.63]	12 [0.42]	2 [0.07]				

Remark: Includes mounting nut and rod end nut.

## Dimensions of Push Side Stroke Adjusting Type (mm)

● Basic type PBDAP  ×

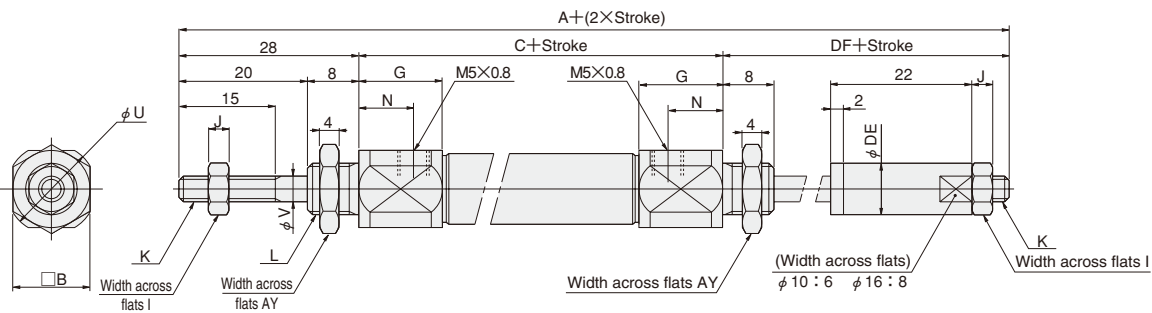

Bore mm [in.]	Code	A	C	B	G	I	J	K	L	N	U	V	AY	DE	DF
<b>10 [0.394]</b>		123.5	60	12	13	7	3.2	M4×0.7	M8×1	8.5	14	4	12	8	35.5
<b>16 [0.630]</b>		122.5	59	17	11.5	8	4	M5×0.8	M10×1	7	19	5	14	10	35.5

# PEN CYLINDERS

## Heat Resistant Specification Cylinders

### Symbol

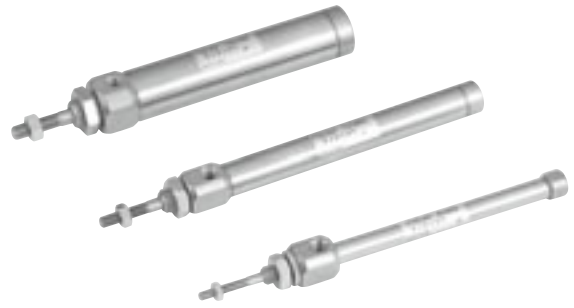
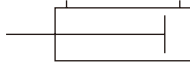

### Specifications

Item	Bore size mm [in.]		
	6 [0.236]	10 [0.394]	16 [0.630]
Operation type	Double acting type		
Mounting type	See the table at lower right.		
Media	Air		
Operating pressure range MPa [psi.]	0.3~0.7 [44~102]	0.2~0.7 [29~102]	0.15~0.7 [22~102]
Proof pressure MPa [psi.]	1.05 [152]		
Operating temperature range °C [°F]	0~150 [32~302]		
Operating speed range mm/s [in./sec.]	50~500 [2.0~19.7]		
Cushion	None	Fixed type (Rubber bumper)	
Lubrication	Not required		
Port size	M5×0.8		

Remark: Fluoro rubber is used for seals. Contact us for details on the specifications.

### Bore Size and Stroke

Bore size	Standard strokes <sup>Note</sup>	mm [in.]	
		Maximum available stroke	Stroke tolerance
6	5, 10, 15, 20, 25, 30, 35, 40, 45, 50, 55, 60	100	
10	5, 10, 15, 20, 25, 30, 35, 40, 45, 50, 55, 60 75, 100, 125, 150	150	+1.5 0 [+0.059] 0
16	5, 10, 15, 20, 25, 30, 35, 40, 45, 50, 55, 60 75, 100, 125, 150, 175, 200	200	

Note: The non-standard stroke:  
For strokes divisible by 5, cylinder tube cutting is used.  
For strokes not divisible by 5, collar packed to the next size up stroke of cylinder.

### Mounting Type

Mounting type	Name	Remark
1	Double foot type	Included at shipping
1A	Single foot type <sup>Note</sup>	Included at shipping
3	Flange type	Included at shipping
7	Clevis type (with pin)	Assembled at the factory for shipping
7-7C	Clevis type with supporting bracket (with pin)	Supporting bracket included at shipping

Note: When the stroke exceeds 60mm, use the double foot type for the foot bracket.

### Order Codes

PB DAF 10×30 - □ - □ - □

Bore size  
×  
Stroke

DAF — Double acting  
single rod type,  
heat resistant  
specification

Pen cylinder series

Rod end accessory (Included at shipping, φ 10 and φ 16 only)

Blank — No rod end accessory

I — With I type knuckle

Y — With Y type knuckle (with pin)

Mounting type (Brackets included at shipping other than clevis mounting type)

Blank — Basic type

1 — Double foot mounting type (Mountable only on head cover -M specification)

1A — Single foot mounting type <sup>Note</sup>

3 — Flange mounting type

7 — Clevis mounting type (with pin) (For φ 10 and φ 16 only)

7-7C — Clevis mounting type with supporting bracket (with pin) (For φ 10 and φ 16 only)

Note: When the stroke exceeds 60mm, use the double foot mounting type for the foot bracket.

Head cover piping specification (Not available in clevis mounting type)

Blank — Axial direction piping

A — Lateral piping

M — Lateral piping with mounting thread (For φ 10 and φ 16 only)

**Caution** Sensor switches cannot be used with the heat resistant specification cylinders.

## Inner Construction (cannot be disassembled)

### ● Double acting type

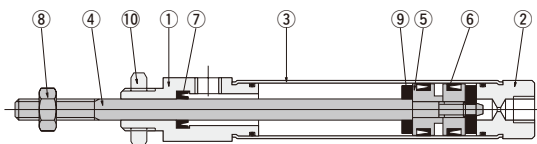

### ● Clevis mounting type (-7)

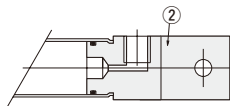

### ● Lateral piping (-A)

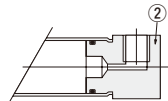

### ● Lateral piping with mounting thread (-M)

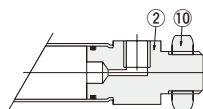

## Major Parts and Materials

No.	Parts	Materials
①	Rod cover	Aluminum alloy (nickel plated)
②	Head cover	
③	Cylinder tube	Stainless steel
④	Piston rod	
⑤	Piston	Aluminum alloy
⑥	Piston seal	Fluoro rubber
⑦	Rod seal	
⑧	Rod end nut	Mild steel (nickel plated)
⑨	Bumper	Fluoro rubber
⑩	Mounting nut	Mild steel (nickel plated)

## Mass

- The mass is the same as the standard double acting type (standard cylinders). See p.260.

## Dimensions

- The dimensions are the same as the standard double acting type. See p.262~264.



# PEN CYLINDERS

## Low Hydraulic Cylinders

### Symbol

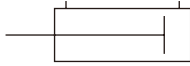

### Specifications

Item	Bore size mm [in.]	6 [0.236]	10 [0.394]	16 [0.630]
Operation type		Double acting type		
Mounting type		See the table at lower right.		
Media <sup>Note1, Note2</sup>		Turbine oil with defoaming agent (ISO VG22~100 or equivalent)		
Operating pressure range MPa [psi.]		0.3~0.7 [44~102]	0.2~0.7 [29~102]	0.15~0.7 [22~102]
Proof pressure MPa [psi.]		1.05 [152]		
Operating temperature range <sup>Note3</sup> °C [°F]		0~60 [32~140]		
Operating speed range <sup>Note4</sup> mm/s [in./sec.]		5~300 [0.2~11.8]		
Cushion		None	Fixed type (Rubber bumper)	
Port size		M5×0.8		

- Notes: 1. The low hydraulic cylinder is recommended to be used with oil on both sides. The use of oil on one side and air on the other side could result in imprecise speed control, and oil could leak across to the air side. In addition, use meter-out control for the speed control.
2. Do not use nonflammable hydraulic fluid, machine oil, or spindle oil.
3. Be aware that changes in oil temperature can alter the speed.
4. When using the reed switch type sensor, maintain a minimum speed of 30mm/s [1.2in./sec.] or more.

### Order Codes

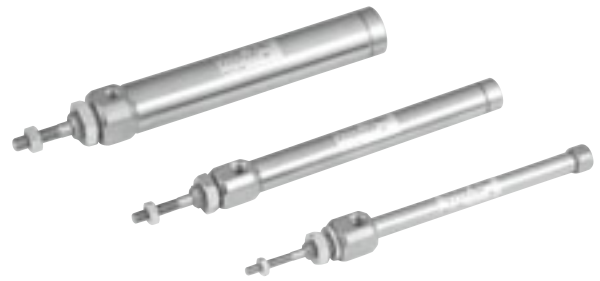
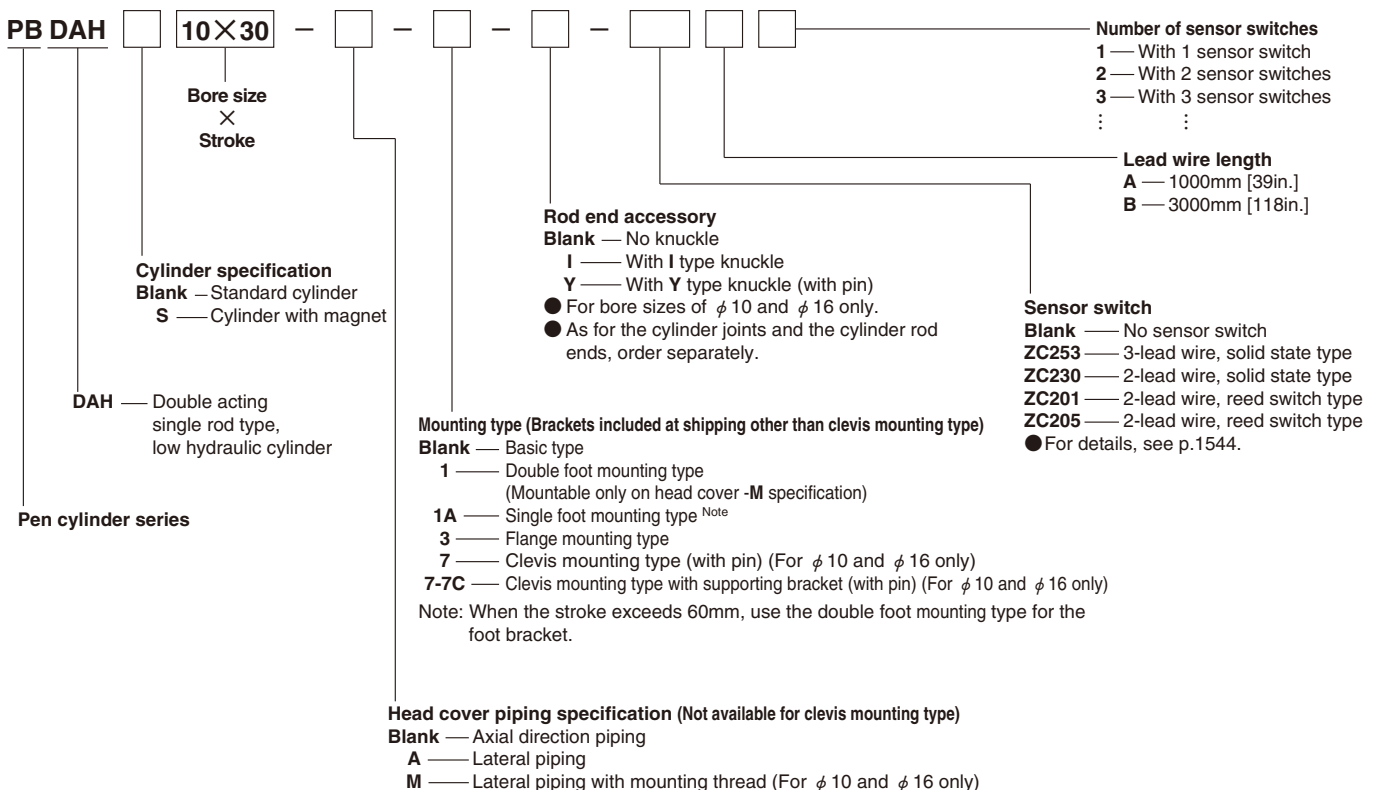

### Bore Size and Stroke

Bore size	Standard strokes <sup>Note</sup>	mm [in.]	
		Maximum available stroke	Stroke tolerance
6	5, 10, 15, 20, 25, 30, 35, 40, 45, 50, 55, 60	100	
10	5, 10, 15, 20, 25, 30, 35, 40, 45, 50, 55, 60 75, 100, 125, 150	150	+1.5 0 [+0.059] 0
16	5, 10, 15, 20, 25, 30, 35, 40, 45, 50, 55, 60 75, 100, 125, 150, 175, 200	200	

Note: The non-standard stroke:  
For strokes divisible by 5, cylinder tube cutting is used.  
For strokes not divisible by 5, collar packed to the next size up stroke of cylinder.

### Mounting Type

Mounting type	Name	Remark
1	Double foot type	Included at shipping
1A	Single foot type <sup>Note</sup>	Included at shipping
3	Flange type	Included at shipping
7	Clevis type (with pin)	Assembled and shipped
7-7C	Clevis type with supporting bracket (with pin)	Supporting bracket included at shipping

Note: When the stroke exceeds 60mm, use the double foot type for the foot bracket.

## Inner Construction (cannot be disassembled)

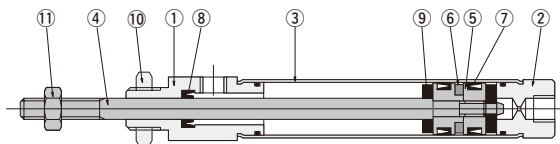

### ● Clevis mounting type (-7)

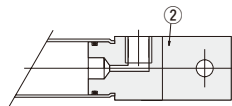

### ● Lateral piping (-A)

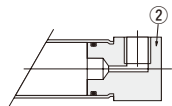

### ● Lateral piping with mounting thread (-M)

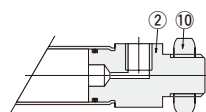

## Major Parts and Materials

No.	Parts	Materials
①	Rod cover	Aluminum alloy (nickel plated)
②	Head cover	
③	Cylinder tube	Stainless steel
④	Piston rod	
⑤	Piston	Aluminum alloy
⑥	Magnet <sup>Note</sup>	Plastic magnet
⑦	Piston seal	Synthetic rubber (NBR)
⑧	Rod seal	
⑨	Bumper	
⑩	Mounting nut	Mild steel (nickel plated)
⑪	Rod end nut	Mild steel (nickel plated)

Note: For cylinders with magnets. Standard cylinders do not have a built-in magnet for the sensor switch.

## Mass

- The mass is the same as the standard double acting type (Standard cylinders). See p.260.

## Dimensions

- The dimensions are the same as the standard double acting type. See p.262~264.

# PEN CYLINDERS

## Dual Stroke Cylinders

### Symbol

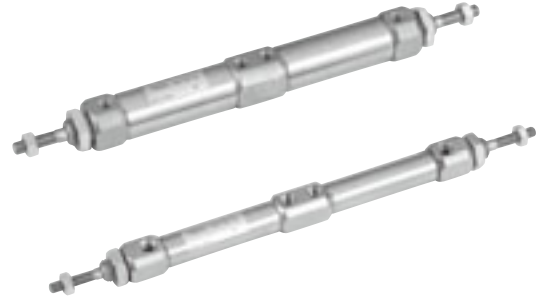

PEN CYLINDERS

### Specifications

Item	Bore size mm [in.]	10 [0.394]	16 [0.630]
Operation type		Double acting type	
Mounting type		See the table at lower right.	
Media		Air	
Operating pressure range	MPa [psi.]	0.08~0.7 [12~102]	0.06~0.7 [9~102]
Proof pressure	MPa [psi.]	1.05 [152]	
Operating temperature range	°C [°F]	0~70 [32~158]	
Operating speed range	mm/s [in./sec.]	50~750 [2.0~29.5]	
Cushion		Fixed type (Rubber bumper)	
Lubrication		Not required	
Port size		M5×0.8	

### Bore Size and Stroke

Bore size	Standard strokes <sup>Note</sup>		Maximum available stroke St1+St2	Stroke tolerance
	Stroke 1	Stroke 2		
10	5, 10, 15, 20, 25, 30	5, 10, 15, 20, 25, 30	120	+1.5 0 [-0.059]
	35, 40, 45, 50, 55, 60	35, 40, 45, 50, 55, 60		
16	5, 10, 15, 20, 25, 30	5, 10, 15, 20, 25, 30	120	+1.5 0 [-0.059]
	35, 40, 45, 50, 55, 60	35, 40, 45, 50, 55, 60		

Note: For non-standard strokes, contact us.

### Mounting Type

Mounting type	Name	Remark
1	Double foot type	Included at shipping
1A	Single foot type <sup>Note</sup>	Included at shipping
3	Flange type	Included at shipping

Note: When the total stroke (St1+St2) exceeds 60mm, use the double foot type for the foot bracket.

### Order Codes

**PB DAW** 10×30×30 -   -   -   -   -   -  

**Pen cylinder series**

**DAW** — Double acting single rod type, dual stroke cylinder

**Cylinder specification**  
**Blank** — Standard cylinder  
**S** — Cylinder with magnet

**Bore size**  
 ×  
**Stroke 1**  
 ×  
**Stroke 2**

**Mounting type (Included at shipping)**  
**Blank** — Basic type  
**1** — Double foot mounting type  
**1A** — Single foot mounting type<sup>Note</sup>  
**3** — Flange mounting type

**Rod end accessory**  
**Blank** — No rod end accessory  
**I** — With I type knuckle  
**Y** — With Y type knuckle (with pin)  
 ● For bore sizes of φ 10 and φ 16 only.  
 ● As for the cylinder joints and the cylinder rod ends, order separately.

**Number of sensor switches**  
**1** — With 1 sensor switch  
**2** — With 2 sensor switches  
**3** — With 3 sensor switches  
 ⋮  
**Lead wire length**  
**A** — 1000mm [39in.]  
**B** — 3000mm [118in.]

**Sensor switch**  
**Blank** — No sensor switch  
**ZC253** — 3-lead wire, solid state type  
**ZC230** — 2-lead wire, solid state type  
**ZC201** — 2-lead wire, reed switch type  
**ZC205** — 2-lead wire, reed switch type  
 ● For details, see p.1544.

Note: When the total stroke (St1+St2) exceeds 60mm, use the double foot mounting type for the foot bracket.

# Inner Construction (cannot be disassembled)

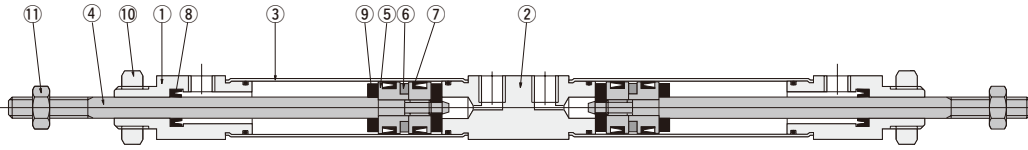

## Major Parts and Materials

No.	Parts	Materials
①	Rod cover	Aluminum alloy (nickel plated)
②	Connecting cover	
③	Cylinder tube	Stainless steel
④	Piston rod	
⑤	Piston	Aluminum alloy
⑥	Magnet <sup>Note</sup>	Plastic magnet
⑦	Piston seal	Synthetic rubber (NBR)
⑧	Rod seal	
⑨	Bumper	
⑩	Mounting nut	Mild steel (nickel plated)
⑪	Rod end nut	

Note: For cylinders with magnets. Standard cylinders do not have a built-in magnet for the sensor switch.

## Operation of Dual Stroke Cylinders

Dual Stroke Cylinders are a set of 2 cylinders connected back to back. The cylinder body can be secured in place and each stroke can be controlled separately. It can also be used to obtain 2-stage or 3-stage strokes by securing the piston rod on one side in place.

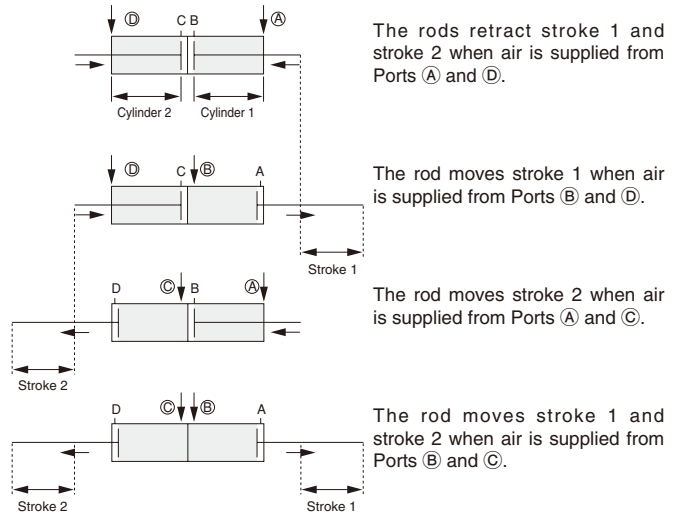

## Mass

Bore size mm [in.]	Zero stroke mass	Additional mass								
		Each 15mm [0.591in.] strokes of St. 1 and St. 2	Mounting bracket			Cylinder with magnet	Lateral piping		Sensor switch	
			-1	-1A	-3		-A	-M	ZC253	ZC230
10 [0.394]	50 [1.76]	3.5 [0.123]	14 [0.49]	7 [0.25]	5 [0.18]	2 [0.07]	2 [0.07]	6 [0.21]	A : 20 [0.71] B : 50 [1.76]	
16 [0.630]	89 [3.14]	5.5 [0.194]	36 [1.27]	18 [0.63]	12 [0.42]	4 [0.14]	3 [0.11]	8 [0.28]		

Remark: Includes mounting nut and rod end nut.

Calculation example: The mass for 2 units of ZC253A, with a double acting cylinder with magnet with single foot bracket, bore size of 10mm, and stroke 1 of 15mm and stroke 2 of 15mm, is 50+2+7+3.5+3.5+20×2 = 106g [3.74oz.]

## Dimensions of Dual Stroke Cylinder (mm)

● Basic type PBDWA  ×  ×

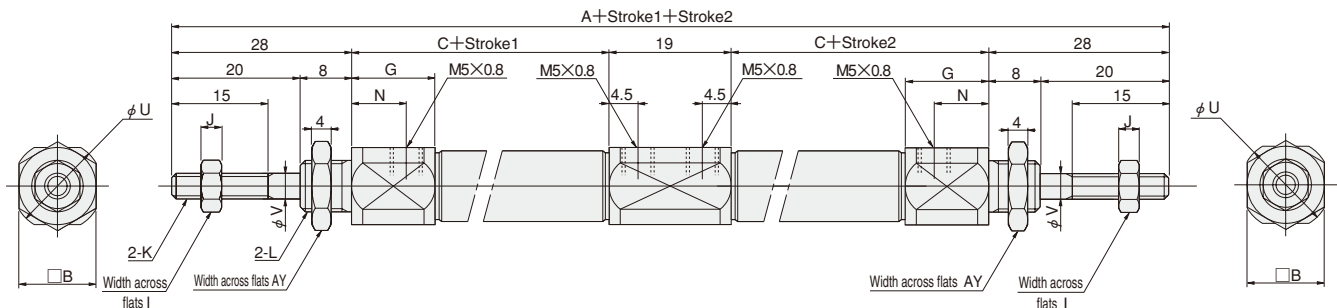

Bore mm [in.]	Code	A	C	B	G	I	J	K	L	N	U	V	AY
10 [0.394]		149	37	12	13	7	3.2	M4×0.7	M8×1	8.5	14	4	12
16 [0.630]		150	37.5	17	11.5	8	4	M5×0.8	M10×1	7	19	5	14

# PEN CYLINDERS

## Tandem Cylinders

### Symbol

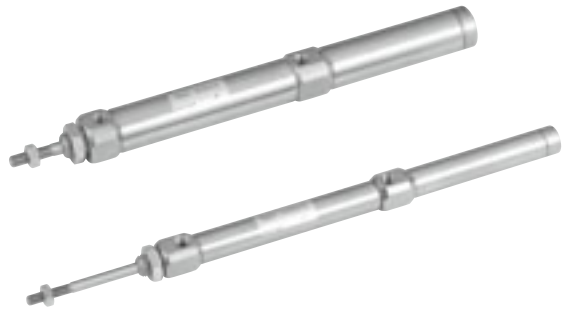
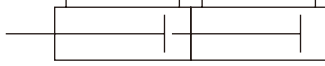

### Specifications

Item	Bore size mm [in.]	10 [0.394]	16 [0.630]
Operation type		Double acting type	
Mounting type		See the table at lower right.	
Media		Air	
Operating pressure range	MPa [psi.]	0.15~0.7 [22~102]	
Proof pressure	MPa [psi.]	1.05 [152]	
Operating temperature range	°C [°F]	0~70 [32~158]	
Operating speed range	mm/s [in./sec.]	50~750 [2.0~29.5]	
Cushion		Fixed type (Rubber bumper)	
Lubrication		Not required	
Port size		M5×0.8	

### Bore Size and Stroke

		mm [in.]		
Stroke1 (standard) <sup>Note</sup>	5, 10, 15, 20, 25, 30, 35, 40, 45, 50, 55, 60	Maximum available stroke (St1×2)+St2	Stroke tolerance	
Bore size				
10	0, 5, 10, 15, 20, 25, 30	150	+1.5 0 +0.059	
16	0, 5, 10, 15, 20, 25, 30	150		

Remark: Figures in the table are a combination of stroke 1 (standard) and its corresponding stroke 2 (standard).  
Note: For non-standard strokes, consult us.

### Mounting Type

Mounting type	Name	Remark
1	Double foot type	Included at shipping
1A	Single foot type <sup>Note</sup>	Included at shipping
3	Flange type	Included at shipping
7	Clevis type (with pin)	Assembled and shipped
7-7C	Clevis type with supporting bracket (with pin)	Supporting bracket included at shipping

Note: When the total stroke (St1×2 + St2) exceeds 60mm, use the double foot type for the foot bracket.

### Order Codes

**PB DAT** 10×30×30 — Bore size × Stroke 1 × Stroke 2

**Cylinder specification**  
Blank — Standard cylinder  
S — Cylinder with magnet

**DAT** — Double acting single rod type, tandem cylinder

**Pen cylinder series**

**Number of sensor switches**  
1 — With 1 sensor switch  
2 — With 2 sensor switches  
3 — With 3 sensor switches  
⋮

**Lead wire length**  
A — 1000mm [39in.]  
B — 3000mm [118in.]

**Sensor switch**  
Blank — No sensor switch  
ZC253 — 3-lead wire, solid state type  
ZC230 — 2-lead wire, solid state type  
ZC201 — 2-lead wire, reed switch type  
ZC205 — 2-lead wire, reed switch type  
● For details, see p.1544.

**Rod end accessory (Included at shipping)**  
Blank — No rod end accessory  
I — With I type knuckle  
Y — With Y type knuckle (with pin)  
● As for the cylinder joints and the cylinder rod ends, order separately.

**Mounting type (Brackets included at shipping other than clevis mounting type)**  
Blank — Basic type  
1 — Double foot mounting type (Mountable only on head cover -M specification)  
1A — Single foot mounting type <sup>Note</sup>  
3 — Flange mounting type  
7 — Clevis mounting type (with pin)  
7-7C — Clevis mounting type with supporting bracket (with pin)

Note: When the total stroke (St1×2+St2) exceeds 60mm, use the double foot mounting type for the foot bracket.

**Head cover piping specification (Not available for clevis mounting type)**  
Blank — Axial direction piping  
A — Lateral piping  
M — Lateral piping with mounting thread

● About Stroke 1 and Stroke 2

## Inner Construction (cannot be disassembled)

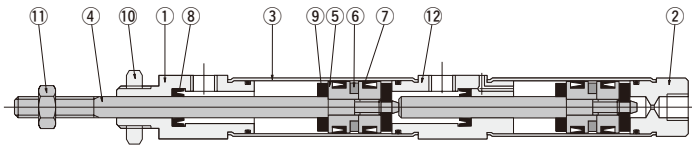

### ● Clevis mounting type (-7)

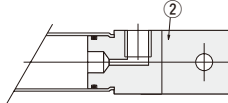

### ● Lateral piping (-A)

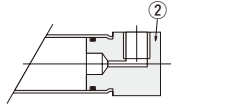

### ● Lateral piping with mounting thread (-M)

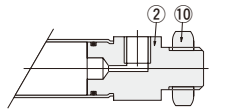

## Major Parts and Materials

No.	Parts	Materials
①	Rod cover	Aluminum alloy (nickel plated)
②	Head cover	
③	Cylinder tube	Stainless steel
④	Piston rod	
⑤	Piston	Aluminum alloy
⑥	Magnet <sup>Note</sup>	Plastic magnet
⑦	Piston seal	Synthetic rubber (NBR)
⑧	Rod seal	
⑨	Bumper	Mild steel (nickel plated)
⑩	Mounting nut	
⑪	Rod end nut	
⑫	Connecting cover	Aluminum alloy (nickel plated)

Note: For cylinders with magnets. Standard cylinders do not have a built-in magnet for the sensor switch.

## Mass

Bore size mm [in.]	Zero stroke mass		Additional mass						g [oz.]
			Each 15 strokes of st. 1 and st. 2	Mounting bracket		Cylinder with magnet	Lateral piping		
	Basic type	Clevis type		-1 <sup>Note</sup>	-3		-A	-M	
10 [0.394]	34 [1.20]	38 [1.34]	3.5 [0.123]	7 [0.25]	5 [0.18]	2 [0.07]	2 [0.07]	6 [0.21]	A : 20 [0.71] B : 50 [1.76]
16 [0.630]	64 [2.26]	76 [2.68]	5.5 [0.194]	18 [0.63]	12 [0.42]	4 [0.14]	3 [0.11]	8 [0.28]	

Note: For the double foot (-1), add double the mass of the single foot bracket.  
Remark: Includes mounting nut and rod end nut.

Calculation example: The mass for 2 units of ZC253A, with a double acting cylinder with magnet with single foot bracket, bore size of 10mm, and stroke 1 of 15mm and stroke 2 of 15mm, is  
 $34 + 2 + 7 + 3.5 + 3.5 + 20 \times 2 = 90\text{g}$  [3.17oz.].

## Operation of Tandem Cylinders

Tandem Cylinders are a set of 2 cylinders joined end to end. It can be used as a 2-stage stroke cylinder by supplying air to either Port A or Port B. It can also obtain twice the thrust within the "stroke 1" range.

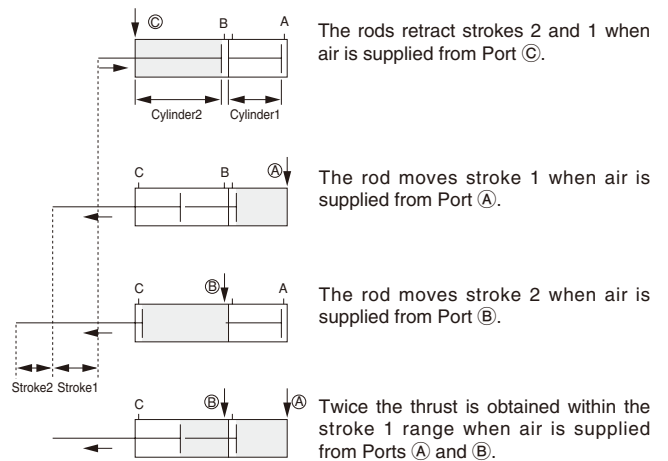

## Example of Air Circuit for Tandem Cylinders

See the following air circuit when using the tandem cylinder as a 2-stage stroke cylinder.

### ● For upward-operation cylinder

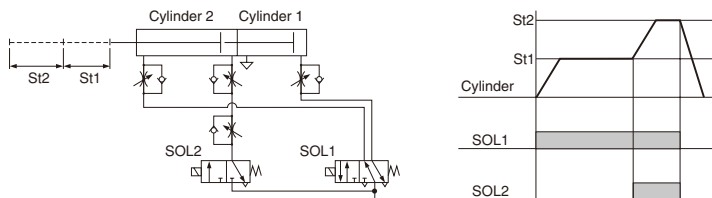

### ● For downward- or horizontal-operation cylinder

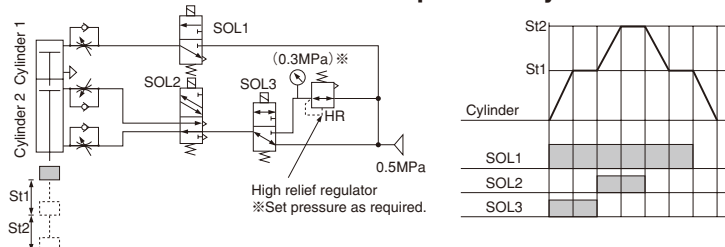

# Dimensions of Tandem Cylinder (mm)

● Basic type PBDAT  Bore size  ×  Stroke 1  ×  Stroke 2

 PBDAT  Bore size

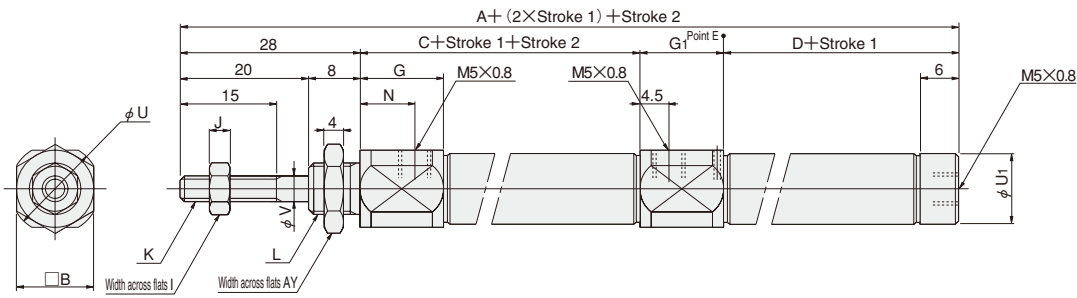

● Lateral piping  
PBDAT  Bore size  ×  Stroke 1  ×  Stroke 2 -A

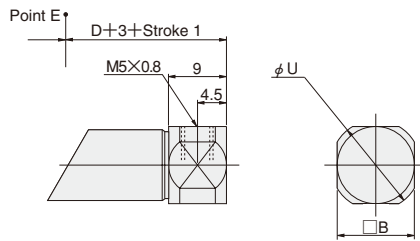

● Lateral piping with mounting thread  
PBDAT  Bore size  ×  Stroke 1  ×  Stroke 2 -M

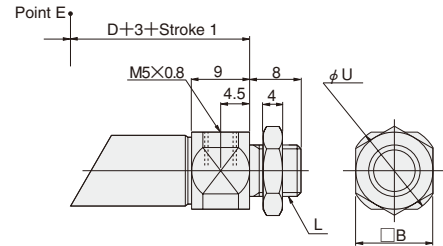

Bore mm [in.]	Code	A	C	B	D	G	G <sub>1</sub>	I	J	K	L	N	U	U <sub>1</sub>	V	AY
10 [0.394]	108	37	12	30	13	13	7	3.2	M4×0.7	M8×1	8.5	14	11	4	12	
16 [0.630]	111.5	37.5	17	32	11.5	14	8	4	M5×0.8	M10×1	7	19	17	5	14	

● Clevis mounting type PBDAT  Bore size  ×  Stroke 1  ×  Stroke 2 -7

 PBDAT  Bore size  7

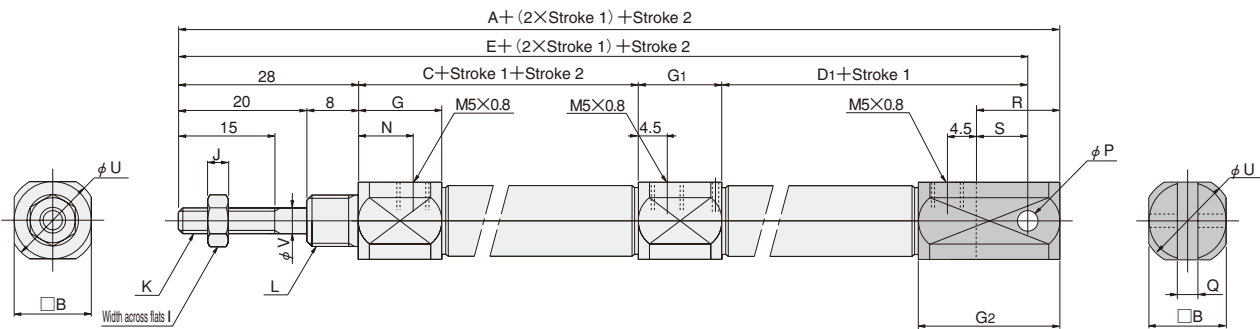

Bore mm [in.]	Code	A	C	B	D <sub>1</sub>	E	G	G <sub>1</sub>	G <sub>2</sub>	I	J	K	L	N	P	Q	R	S	U	V
10 [0.394]	124	37	12	41	119	13	13	22	7	3.2	M4×0.7	M8×1	8.5	3.2 <sup>+0.09</sup> <sub>+0.06</sub>	3.2 <sup>+0.2</sup> <sub>+0.1</sub>	13	8	14	4	
16 [0.394]	132.5	37.5	17	45	124.5	11.5	14	27	8	4	M5×0.8	M10×1	7	5 <sup>+0.09</sup> <sub>+0.06</sub>	6.5 <sup>+0.2</sup> <sub>+0.1</sub>	18	10	19	5	

# PEN CYLINDERS

## Cylinders for Clean Systems



### Symbols

- Double acting type
- Single acting push type



### Specifications

Item	Bore size mm [in.]		
	6 [0.236]	10 [0.394]	16 [0.630]
Operation type	Double acting type, Single acting push type		
Media	Air		
Mounting type	Basic type, Foot type, Flange type, Clevis type (clevis type of $\phi$ 10 and $\phi$ 16 only)		
Operating pressure range MPa [psi.]	Double acting type	0.15~0.7 [22~102]	0.1~0.7 [15~102]
	Single acting push type	0.3~0.7 [44~102]	0.15~0.7 [22~102]
Proof pressure	MPa [psi.] 1.05 [152]		
Operating temperature range	°C [°F] 0~60 [32~140]		
Operating speed range	mm/s [in./sec.] 50~300 [2.0~11.8]		
Cushion	None	Rubber bumper	
Lubrication	Not required		
Port size	M5×0.8 <sup>Note</sup>		

Note: M3×0.5 can also be selected at  $\phi$  6 only.

### Bore Size and Stroke

● Double acting type				mm [in.]
Bore size	Standard strokes <sup>Note</sup>	Maximum available stroke	Stroke tolerance	
6	5, 10, 15, 20, 25, 30, 35, 40, 45, 50, 55, 60	100		
10	5, 10, 15, 20, 25, 30, 35, 40, 45, 50, 55, 60 75, 100, 125, 150	150	+1.5 0 [-0.059]	
16	5, 10, 15, 20, 25, 30, 35, 40, 45, 50, 55, 60 75, 100, 125, 150, 175, 200	200		

● Single acting type					mm [in.]
Operation type	Bore size	Standard strokes <sup>Note</sup>	Maximum available stroke	Stroke tolerance	
Single acting push type	6	5, 10, 15, 20, 25, 30, 35, 40, 45, 50, 55, 60	75	+1.5 0 [-0.059]	
	10		105		
	16		120		

Note: The non-standard stroke:

For strokes divisible by 5, cylinder tube cutting is used.

For strokes not divisible by 5, collar packed to the next size up stroke of cylinder.

### Order Codes

**CS** — Pen cylinder series  
**Cylinders for clean systems**

**PB** — Head cover piping specification  
**Blank** — Axial direction piping  
**A** — Lateral piping (not available for clevis mounting type)  
**M** — Lateral piping with mounting thread\*  
\* -M available only in  $\phi$  10 and  $\phi$  16 of double acting type and single acting push type. Not available for clevis mounting type.

**10×30** — Bore size × Stroke

**Cylinder specification**  
**Blank** — Standard cylinder  
**S** — Cylinder with magnet

**Operation type**  
**DA** — Double acting type  
**SA** — Single acting push type

**Number of sensor switches**  
**1** — With 1 sensor switch  
**2** — With 2 sensor switches  
**3** — With 3 sensor switches  
⋮

**Lead wire length**  
**A** — 1000mm [39in.]  
**B** — 3000mm [118in.]

**Sensor switch**  
**Blank** — No sensor switch  
**ZC253** — 3-lead wire, solid state type  
**ZC230** — 2-lead wire, solid state type  
**ZC201** — 2-lead wire, reed switch type  
**ZC205** — 2-lead wire, reed switch type  
● For details, see p.1544.

**Mounting type (Included at shipping other than clevis mounting type)**  
**Blank** — Basic type  
**1** — Double foot mounting type (Mountable only on  $\phi$  10 and  $\phi$  16 of head cover -M specification double acting type and -M specification single acting push type)  
**1A** — Single foot mounting type  
**3** — Flange mounting type  
**7** — Clevis mounting type (with pin for bore sizes of  $\phi$  10 and  $\phi$  16 only)  
**7-7C** — Clevis mounting type with pin and clevis supporting bracket (For bore sizes of  $\phi$  10 and  $\phi$  16 only)

**Connection port**  
**Blank** — M5×0.8 ( $\phi$  6,  $\phi$  10,  $\phi$  16)  
**M3** — M3×0.5 ( $\phi$  6 only)



## Order Codes for Mounting Brackets Only

Name \ Bore size mm	6	10	16
Single foot bracket	<b>CS-1A-PBDA6</b>	<b>CS-1A-PBDA10</b>	<b>CS-1A-PBDA16</b>
Double foot bracket	<b>CS-1-PBDA6</b>	<b>CS-1-PBDA10</b>	<b>CS-1-PBDA16</b>
Flange bracket	<b>CS-3-PBDA6</b>	<b>CS-3-PBDA10</b>	<b>CS-3-PBDA16</b>
Clevis supporting bracket	—	<b>CS-7C-PBDA10</b>	<b>CS-7C-PBDA16</b>

## Mounting type

Mounting type	Name	Remark
<b>1</b>	Double foot type	Included at shipping
<b>1A</b>	Single foot type <sup>Note</sup>	Included at shipping
<b>3</b>	Flange type	Included at shipping
<b>7</b>	Clevis type (with pin)	Assembled and shipped
<b>7-7C</b>	Clevis type with supporting bracket (with pin)	Supporting bracket included at shipping

Note: When the stroke exceeds 60mm, use the double foot type for the foot bracket.

## Mass

Operation type	Mounting type	Bore mm	Stroke mm																	Additional mass				Additional mass of Lateral piping		
			5	10	15	20	25	30	35	40	45	50	55	60	75	100	125	150	175	200	Mounting type				Sensor switch (1 pc.) <sup>Note 2</sup>	
			Single foot	Flange	Clevis <sup>Note 1</sup>	Cylinder with magnet	Sensor switch																			
Double acting type	Basic type	6	18.8 [0.663]	19.4 [0.684]	20 [0.705]	20.8 [0.734]	21.4 [0.755]	22 [0.776]	22.4 [0.790]	22.8 [0.804]	23 [0.811]	23.6 [0.832]	24.2 [0.854]	25 [0.882]	—	—	—	—	—	7 [0.25]	5 [0.18]	—	0.5 [0.018]	A : 20 [0.71] B : 50 [1.76]	—	
		10	27 [0.952]	28 [0.988]	29 [1.023]	30 [1.058]	31 [1.093]	32 [1.129]	33.3 [1.175]	34.6 [1.220]	36 [1.270]	37 [1.305]	38 [1.340]	39 [1.376]	42.4 [1.496]	48.1 [1.697]	53.8 [1.898]	59.5 [2.099]	—	—	7 [0.25]	5 [0.18]	—		1 [0.04]	2 [0.07]
		16	47.8 [1.686]	49.4 [1.743]	51 [1.799]	52.6 [1.855]	54.2 [1.912]	56 [1.975]	57.6 [2.032]	59.2 [2.088]	61 [2.152]	62.3 [2.198]	63.6 [2.243]	66 [2.328]	71.3 [2.515]	80.1 [2.825]	88.9 [3.136]	97.7 [3.446]	106.5 [3.757]	115.3 [4.067]	18 [0.63]	12 [0.42]	—		2 [0.07]	3 [0.11]
	Clevis mounting type (with pin)	10	30.8 [1.086]	31.9 [1.125]	33 [1.164]	33.8 [1.192]	34.9 [1.231]	36 [1.270]	37.8 [1.333]	38.9 [1.372]	40 [1.411]	40.8 [1.439]	41.9 [1.478]	43 [1.517]	46.3 [1.633]	51.8 [1.827]	57.3 [2.021]	62.8 [2.215]	—	—	—	—	32 [1.13]		1 [0.04]	—
		16	59.4 [2.095]	61.2 [2.159]	63 [2.222]	64.4 [2.272]	66.2 [2.335]	68 [2.399]	69.4 [2.448]	71.2 [2.511]	73 [2.575]	74.4 [2.624]	76.2 [2.688]	78 [2.751]	83.4 [2.942]	92.4 [3.259]	101.4 [3.577]	110.4 [3.894]	119.4 [4.212]	128.4 [4.529]	—	—	45 [1.59]		2 [0.07]	—
		6	15.8 [0.557]	16.4 [0.578]	17 [0.600]	19.8 [0.698]	20.4 [0.720]	21 [0.741]	22.8 [0.804]	23.4 [0.825]	24 [0.847]	24.8 [0.875]	25.4 [0.896]	26 [0.917]	—	—	—	—	—	—	7 [0.25]	5 [0.18]	—		0.5 [0.018]	—
Single acting push type	Basic type	10	26.8 [0.945]	27.9 [0.984]	29 [1.023]	31.8 [1.122]	32.9 [1.160]	34 [1.199]	39.8 [1.404]	40.9 [1.443]	42 [1.481]	42.8 [1.510]	43.9 [1.549]	45 [1.587]	—	—	—	—	—	—	18 [0.63]	12 [0.42]	—	1 [0.04]	2 [0.07]	
		16	50.4 [1.778]	52.2 [1.841]	54 [1.905]	58.4 [2.060]	60.2 [2.123]	62 [2.187]	72.4 [2.554]	74.2 [2.617]	76 [2.681]	77.4 [2.730]	79.2 [2.794]	81 [2.857]	—	—	—	—	—	—	18 [0.63]	12 [0.42]	—	2 [0.07]	3 [0.11]	
		6	15.8 [0.557]	16.4 [0.578]	17 [0.600]	19.8 [0.698]	20.4 [0.720]	21 [0.741]	22.8 [0.804]	23.4 [0.825]	24 [0.847]	24.8 [0.875]	25.4 [0.896]	26 [0.917]	—	—	—	—	—	—	7 [0.25]	5 [0.18]	—	0.5 [0.018]	—	
	Clevis mounting type (with pin)	10	29.8 [1.051]	30.9 [1.090]	32 [1.129]	34.8 [1.228]	35.9 [1.266]	37 [1.305]	42.8 [1.510]	43.9 [1.549]	45 [1.587]	45.8 [1.616]	46.9 [1.654]	48 [1.693]	—	—	—	—	—	—	—	—	32 [1.13]	1 [0.04]	—	
		16	61.4 [2.166]	63.2 [2.229]	65 [2.293]	69.4 [2.448]	71.2 [2.511]	73 [2.575]	83.4 [2.942]	83.4 [2.942]	87 [3.069]	88.4 [3.118]	90.2 [3.182]	92 [3.245]	—	—	—	—	—	—	—	—	45 [1.59]	2 [0.07]	—	
		6	15.8 [0.557]	16.4 [0.578]	17 [0.600]	19.8 [0.698]	20.4 [0.720]	21 [0.741]	22.8 [0.804]	23.4 [0.825]	24 [0.847]	24.8 [0.875]	25.4 [0.896]	26 [0.917]	—	—	—	—	—	—	7 [0.25]	5 [0.18]	—	0.5 [0.018]	—	

Remark : Includes mounting nut and rod end nut. The clevis mounting type does not include mounting nut.

For the mass of the double foot bracket, add double the mass of the single foot bracket listed above.

Notes: 1. With supporting bracket and pin.

2. Same for all sensor switch models (ZC253□, ZC230□, ZC201□, ZC205□).

Calculation example: The mass for 2 units of ZC253A, with a double acting cylinder with magnet with single foot bracket, bore size of 10mm, and stroke of 45mm, is  $36 + 7 + 1 + 40 = 84\text{g}$  [2.96oz.].

## Inner Construction (cannot be disassembled)

### ● Double acting type

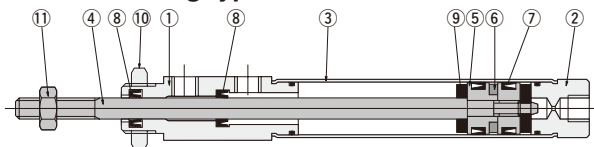

### ● Single acting push type

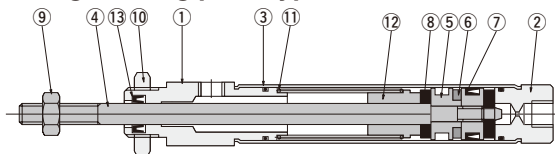

## Major Parts and Materials

No.	Parts	Materials
①	Rod cover	Aluminum alloy (nickel plated)
②	Head cover	
③	Cylinder tube	Stainless steel
④	Piston rod	
⑤	Piston	Aluminum alloy
⑥	Magnet <sup>Note</sup>	Plastic magnet
⑦	Piston seal	Synthetic rubber (NBR)
⑧	Rod seal	
⑨	Bumper	
⑩	Mounting nut	Mild steel (nickel plated)
⑪	Rod end nut	

Note: For cylinders with magnets. Standard cylinders do not have a built-in magnet for the sensor switch.

No.	Parts	Materials
①	Rod cover	Aluminum alloy (nickel plated)
②	Head cover	
③	Cylinder tube	Stainless steel
④	Piston rod	
⑤	Piston	Aluminum alloy
⑥	Magnet <sup>Note1</sup>	Plastic magnet
⑦	Piston seal	Synthetic rubber (NBR)
⑧	Bumper	
⑨	Rod end nut	Mild steel (nickel plated)
⑩	Mounting nut	
⑪	Spring	Steel
⑫	Collar	Aluminum alloy
⑬	Rod seal	Synthetic rubber (NBR)

Note: For cylinders with magnets. Standard cylinders do not have a built-in magnet for the sensor switch.



# Dimensions of Single Acting Push Type Cylinder for Clean Systems (mm)

## ● Basic type CS - PBSA Bore size Stroke

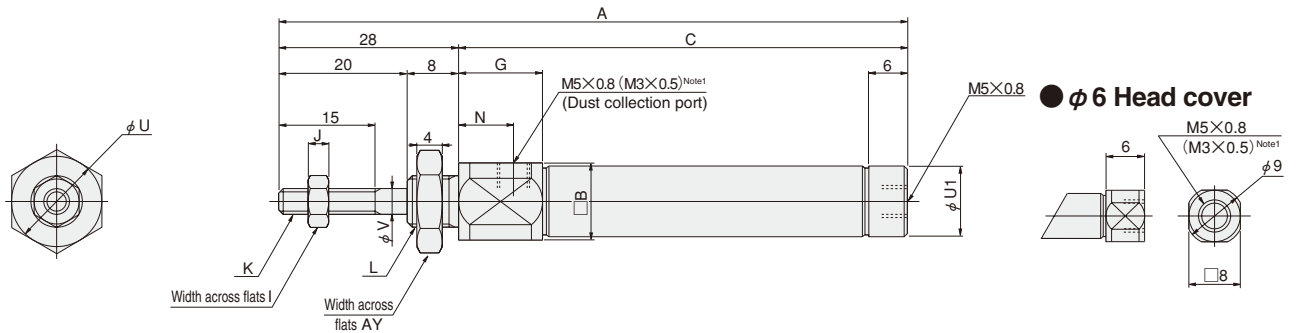

## ● Lateral piping (-A) CS - PBSA Bore size Stroke -A

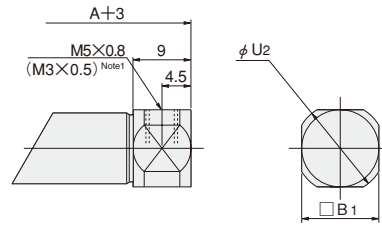

## ● Lateral piping with mounting thread (-M) Note 2 CS - PBSA Bore size Stroke -M

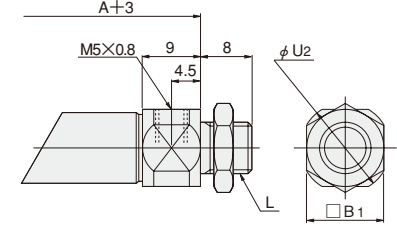

Notes: 1. For bore size  $\phi 6$  only.  
2. Not available for bore size  $\phi 6$ .

Code	A												C											
	Stroke	5	10	15	20	25	30	35	40	45	50	55	60	5	10	15	20	25	30	35	40	45	50	55
6 [0.236]	87	92	97	107	112	117	137	142	147	152	157	162	59	64	69	79	84	89	109	114	119	124	129	134
10 [0.394]	86	91	96	106	111	116	131	136	141	146	151	156	58	63	68	78	83	88	103	108	113	118	123	128
16 [0.630]	86.5	91.5	96.5	106.5	111.5	116.5	131.5	136.5	141.5	146.5	151.5	156.5	58.5	63.5	68.5	78.5	83.5	88.5	103.5	108.5	113.5	118.5	123.5	128.5

Code	B	B <sub>1</sub>	G	I	J	K	L	N	U	U <sub>1</sub>	U <sub>2</sub>	V	AY
6 [0.236]	12	8	14.5	5.5	2.4	M3x0.5	M8x1	8	14	—	10.8	3	12
10 [0.394]	12	12	13	7	3.2	M4x0.7	M10x1	8.5	14	11	14	4	14
16 [0.630]	17	17	11.5	8	4	M5x0.8	M12x1	7	19	17	19	5	17

## ● Clevis mounting type CS - PBSA Bore size Stroke -7

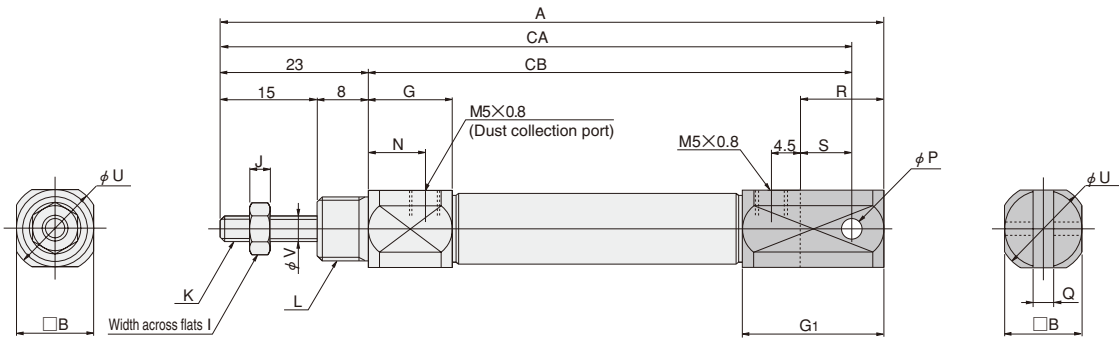

Code	A												CA												CB											
	Stroke	5	10	15	20	25	30	35	40	45	50	55	60	5	10	15	20	25	30	35	40	45	50	55	60	5	10	15	20	25	30	35	40	45	50	55
10 [0.394]	97	102	107	117	122	127	142	147	152	157	162	167	92	97	102	112	117	122	137	142	147	152	157	162	69	74	79	89	94	99	114	119	124	129	134	139
16 [0.630]	102.5	107.5	112.5	122.5	127.5	132.5	147.5	152.5	157.5	162.5	167.5	172.5	94.5	99.5	104.5	114.5	119.5	124.5	139.5	144.5	149.5	154.5	159.5	164.5	71.5	76.5	81.5	91.5	96.5	101.5	116.5	121.5	126.5	131.5	136.5	141.5

Code	B	G	G <sub>1</sub>	I	J	K	L	N	P	Q	R	S	U	V
10 [0.394]	12	13	22	7	3.2	M4x0.7	M10x1	8.5	3.2 <sup>+0.09</sup> / <sub>+0.06</sub>	3.2 <sup>+0.2</sup> / <sub>+0.1</sub>	13	8	14	4
16 [0.630]	17	11.5	27	8	4	M5x0.8	M12x1	7	5 <sup>+0.09</sup> / <sub>+0.06</sub>	6.5 <sup>+0.2</sup> / <sub>+0.1</sub>	18	10	19	5

# MADE TO ORDER PEN CYLINDERS

## Cylinders with Variable Cushions

### Symbol

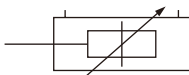

### Specifications

Item	Bore size mm [in.]	
	10 [0.394]	16 [0.630]
Operation type	Double acting type	
Mounting type	See the table at lower right.	
Media	Air	
Operating pressure range MPa [psi.]	0.2~0.7 [29~102]	0.1~0.7 [15~102]
Proof pressure MPa [psi.]	1.05 [152]	
Operating temperature range °C [°F]	0~70 [32~158]	
Operating speed range mm/s [in./sec.]	100~1000 [3.9~39.4]	
Cushion	Variable cushion type	
Cushion stroke mm [in.]	8 [0.315]	10 [0.394]
Allowable kinetic energy J [in.-lbf]	0.07 [0.62]	0.18 [1.59]
Lubrication	Not required	
Port size	M5×0.8	

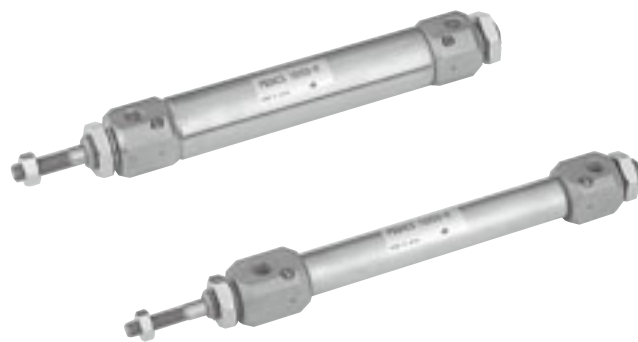

● For delivery, consult us.

### Bore Size and Stroke

Bore size	Standard strokes <sup>Note</sup>	Maximum available stroke	Stroke tolerance
			mm [in.]
10	25, 50, 75, 100	150	+1.5 0
16	25, 50, 75, 100	300	[+0.059 0]

Note: For non-standard strokes, consult us.

### Mounting Type

Mounting type	Name	Remark
1	Double foot type	Included at shipping
1A	Single foot type <sup>Note</sup>	Included at shipping
3	Flange type	Included at shipping
7	Clevis type (with pin)	Assembled and shipped
7-7C	Clevis type with supporting bracket (with pin)	Supporting bracket included at shipping

Note: When the stroke exceeds 60mm, use the double foot type for the foot bracket.

### Order Codes

**PB DAC S 10×25 - M -** [ ] - [ ] - [ ] [ ] [ ]

**Pen cylinder series**

**PB** — Pen cylinder series

**DAC** — Double acting single rod type, with variable cushion

**S** — Cylinder with magnet (magnet is standard equipment)

**10×25** — Bore size × Stroke

**M** — Head cover piping specification (Not available for clevis mounting type)

**M** — Lateral piping with mounting thread

**Number of sensor switches**

- 1 — With 1 sensor switch
- 2 — With 2 sensor switches
- 3 — With 3 sensor switches
- ⋮

**Lead wire length**

- A — 1000mm [39in.]
- B — 3000mm [118in.]

**Rod end accessory (Included at shipping)**

- Blank — No rod end accessory
- I — With I type knuckle
- Y — With Y type knuckle (with pin)
- As for the cylinder joints and the cylinder rod ends, order separately.

**Mounting type (Brackets included at shipping other than clevis mounting type)**

- Blank — Basic type
- 1 — Double foot mounting type (Mountable only on head cover -M specification)
- 1A — Single foot mounting type<sup>Note</sup>
- 3 — Flange mounting type
- 7 — Clevis mounting type (with pin)
- 7-7C — Clevis mounting type with supporting bracket (with pin)

Note: When the stroke exceeds 60mm, use the double foot mounting type for the foot bracket.

**Sensor switch**

- Blank — No sensor switch
- ZC253 — 3-lead wire, solid state type
- ZC230 — 2-lead wire, solid state type
- ZC201 — 2-lead wire, reed switch type
- ZC205 — 2-lead wire, reed switch type
- For details, see p.1544.

## Inner Construction (cannot be disassembled)

### ● Double acting type

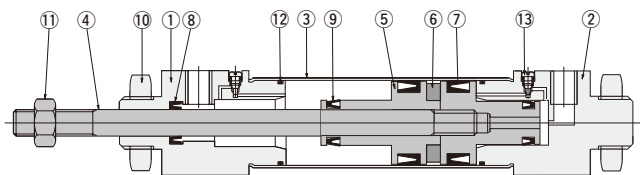

### ● Clevis mounting type (-7)

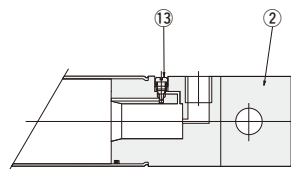

## Major Parts and Materials

No.	Parts	Materials
①	Rod cover	Aluminum alloy (nickel plated)
②	Head cover	
③	Cylinder tube	Stainless steel
④	Piston rod	
⑤	Piston	Aluminum alloy
⑥	Magnet	Plastic magnet
⑦	Piston seal	Synthetic rubber (NBR)
⑧	Rod seal	
⑨	Cushion seal	
⑩	Mounting nut	Mild steel (nickel plated)
⑪	Rod end nut	
⑫	Tube gasket	Synthetic rubber (NBR)
⑬	Needle	Stainless steel

## Mass

Bore size mm [in.]	Mounting type	Stroke mm				Additional mass					g [oz.]			
						Mounting bracket				Cylinder with magnet		Sensor switch		
		25	50	75	100	-1A	-1	-3	-7			ZC253 □	ZC230 □	ZC201 □
<b>10 [0.394]</b>	Basic type	36 [1.27]	42 [1.48]	48 [1.69]	53 [1.87]	7 [0.25]	14 [0.49]	5 [0.18]	—	1 [0.04]	A : 20 [0.71] B : 50 [1.76]			
<b>16 [0.630]</b>		58 [2.05]	67 [2.36]	76 [2.68]	85 [3.00]	18 [0.63]	36 [1.27]	12 [0.42]	—	2 [0.07]				
<b>10 [0.394]</b>	Clevis mounting type	40 [1.41]	46 [1.62]	52 [1.83]	57 [2.01]	—	—	—	20 [0.71]	1 [0.04]	A : 20 [0.71] B : 50 [1.76]			
<b>16 [0.630]</b>		69 [2.43]	78 [2.75]	87 [3.07]	96 [3.39]	—	—	—	33 [1.16]	2 [0.07]				

Remark: Includes mounting nut and rod end nut.

## Dimensions of Cylinder with Variable Cushion (mm)

### ● Basic type PBDACS × -M

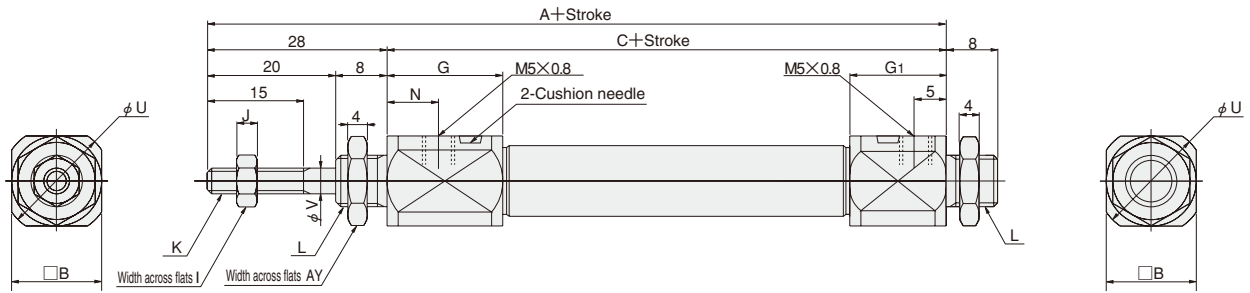

Bore mm [in.]	Code	A	C	B	G	G <sub>1</sub>	I	J	K	L	N	U	V	AY
10 [0.394]		85	57	14	18	15	7	3.2	M4×0.7	M8×1	8	17	4	12
16 [0.630]		85	57	17	16.5	14.5	8	4	M5×0.8	M10×1	7	19	5	14

### ● Clevis mounting type PBDACS × -7

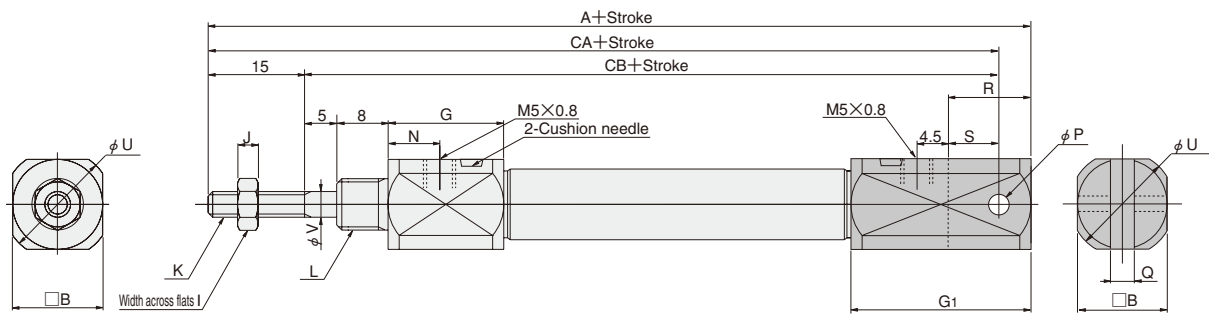

Bore mm [in.]	Code	A	B	G	G <sub>1</sub>	I	J	K	L	N	P	Q	R	S	U	V	CA	CB
10 [0.394]		98	14	18	28	7	3.2	M4×0.7	M8×1	8	3.2 <sup>+0.09</sup> <sub>+0.06</sub>	3.2 <sup>+0.2</sup> <sub>+0.1</sub>	13	8	17	4	93	78
16 [0.630]		103	17	16.5	32.5	8	4	M5×0.8	M10×1	7	5 <sup>+0.09</sup> <sub>+0.06</sub>	6.5 <sup>+0.2</sup> <sub>+0.1</sub>	18	10	19	5	95	80

# MADE TO ORDER PEN CYLINDERS

## Linear Bearing Type Cylinders

### Symbol

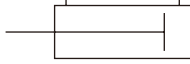

### Specifications

Item	Bore size mm [in.]	10 [0.394]	16 [0.630]
Operation type		Double acting type	
Mounting type		See the table at lower right.	
Media		Air	
Operating pressure range	MPa [psi.]	0.12~0.7 [17~102]	0.1~0.7 [15~102]
Proof pressure	MPa [psi.]	1.05 [152]	
Operating temperature range	°C [°F]	0~70 [32~158]	
Operating speed range	mm/s [in./sec.]	50~750 [2.0~29.5]	
Cushion		Fixed type (Rubber bumper)	
Lubrication		Not required	
Port size		M5×0.8	

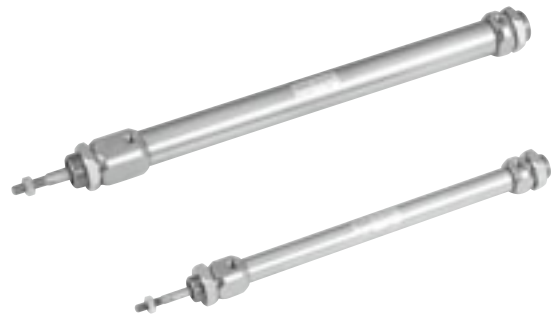

● For delivery, consult us.

### Bore Size and Stroke

Bore size	Standard strokes <sup>Note</sup>	Maximum available stroke	Stroke tolerance
			mm [in.]
10	25, 50, 75, 100	300	+1.5 0
16	25, 50, 75, 100	500	+0.059 0

Note: For non-standard strokes, consult us.

### Mounting Type

Mounting type	Name	Remark
1	Double foot type	Included at shipping
1A	Single foot type <sup>Note</sup>	Included at shipping
3	Flange type	Included at shipping
7	Clevis type (with pin)	Assembled and shipped
7-7C	Clevis type with supporting bracket (with pin)	Supporting bracket included at shipping

Note: When the stroke exceeds 60mm, use the double foot type for the foot bracket.

### Order Codes

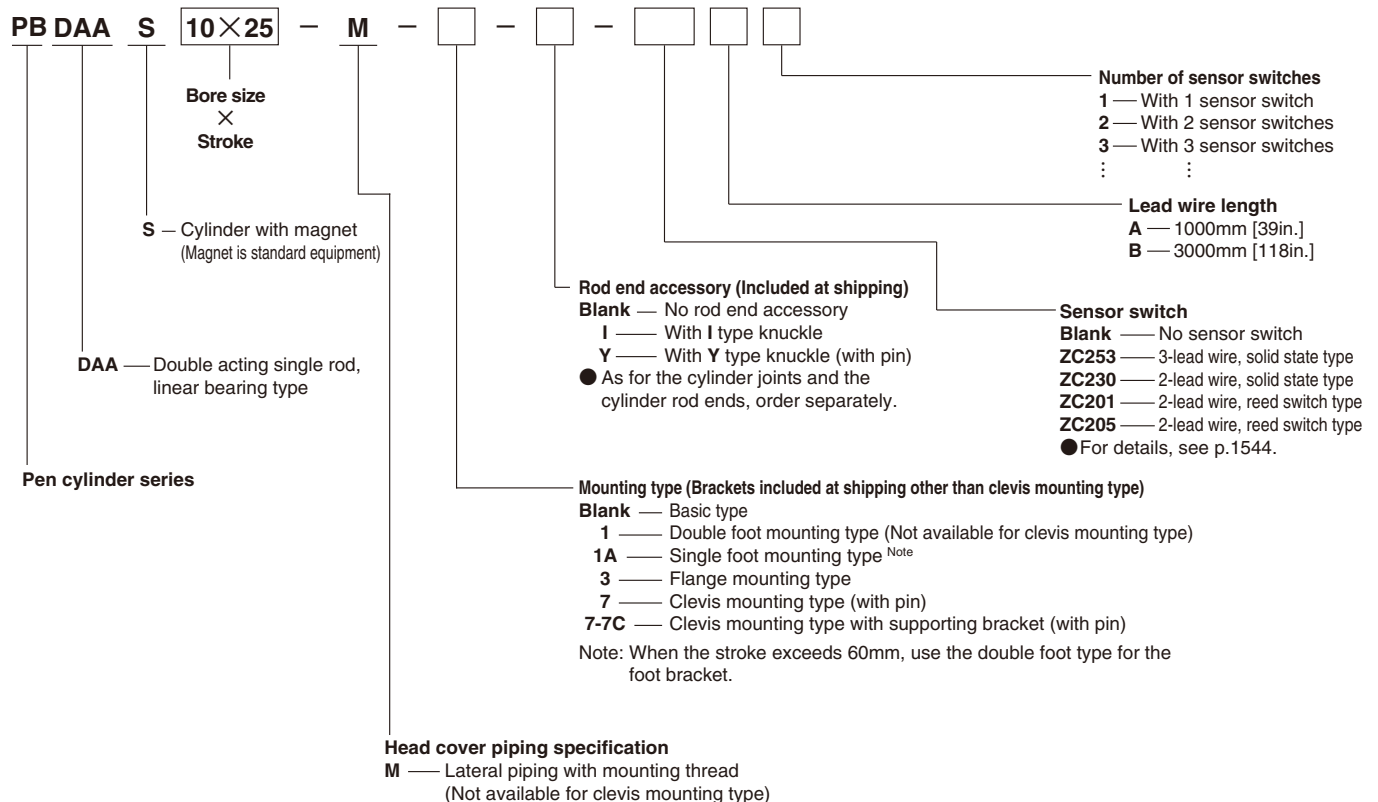



## Inner Construction (cannot be disassembled)

### ● Double acting type

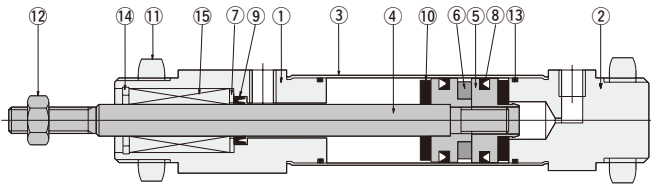

### ● Clevis mounting type (-7)

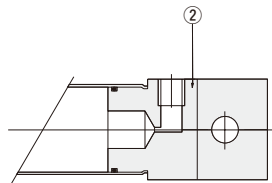

## Major Parts and Materials

No.	Parts	Materials
①	Rod cover	Aluminum alloy (nickel plated)
②	Head cover	
③	Cylinder tube	Stainless steel
④	Piston rod	Steel
⑤	Piston	Aluminum alloy
⑥	Magnet	Plastic magnet
⑦	Washer	Mild steel
⑧	Piston seal	Synthetic rubber (NBR)
⑨	Rod seal	
⑩	Bumper	
⑪	Mounting nut	Brass (nickel plated)
⑫	Rod end nut	Mild steel (nickel plated)
⑬	Tube gasket	Synthetic rubber (NBR)
⑭	Snap ring	Steel
⑮	Linear bearing	—

PEN CYLINDERS

## Mass

Bore size mm [in.]	Mounting type	Stroke mm				Additional mass						g [oz.]		
						Mounting bracket				Cylinder with magnet	Sensor switch			
		25	50	75	100	-1A	-1	-3	-7		1		2	ZC253 □
10 [0.394]	Basic type	48 [1.69]	54 [1.90]	59 [2.08]	65 [2.29]	19 [0.67]	38 [1.34]	10 [0.35]	—	1 [0.04]	A : 20 [0.71] B : 50 [1.76]			
16 [0.630]		95 [3.35]	106 [3.74]	117 [4.13]	127 [4.48]	38 [1.34]	76 [2.68]	25 [0.88]	—	2 [0.07]				
10 [0.394]	Clevis mounting type	52 [1.83]	58 [2.05]	63 [2.22]	69 [2.43]	—	—	—	20 [0.71]	1 [0.04]	A : 20 [0.71] B : 50 [1.76]			
16 [0.630]		106 [3.74]	117 [4.13]	128 [4.51]	138 [4.87]	—	—	—	33 [1.16]	2 [0.07]				

Remark: Includes mounting nut and rod end nut.

## Allowable Lateral Load

- Keep the lateral load applied on the end of the piston rod below the values in the graph.

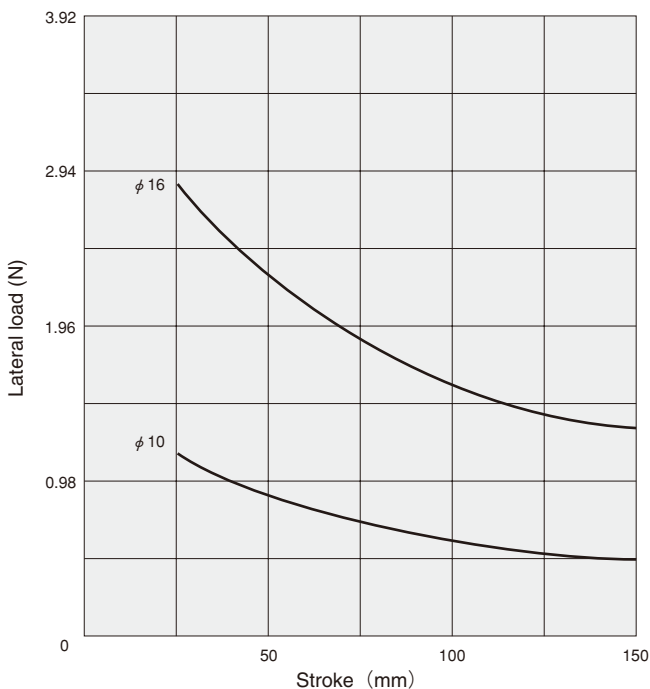

1N = 0.2248lbf.  
1mm = 0.0394in.

## Deflection at the End of the Piston Rod

- Deflection at the end of the piston rod with a non-load state does not exceed the values in the graph.

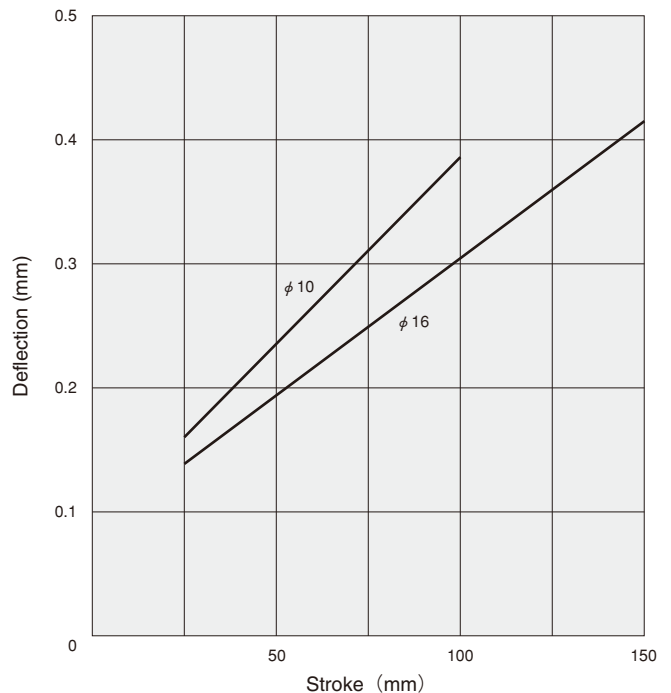

1mm = 0.0394in.

## Dimensions of Linear Bearing Type Cylinder (mm)

### ● Basic type PBDAAS × -M

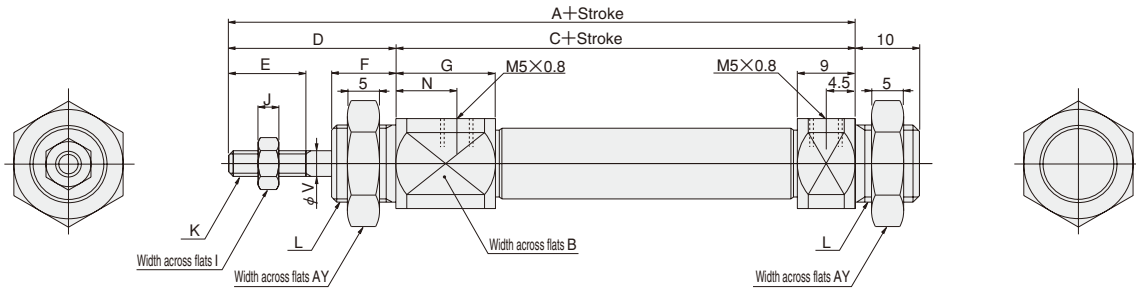

Bore mm [in.]	Code	A	C	B	D	E	F	G	I	J	K	L	N	V	AY
10 [0.394]		78	52	14	26	12	10	14	7	3.2	M4×0.7	M12×1	9.5	4	17
16 [0.630]		94	62	19	32	15	12	22	8	4	M5×0.8	M16×1	17.5	6	20

### ● Clevis mounting type PBDAAS × -7

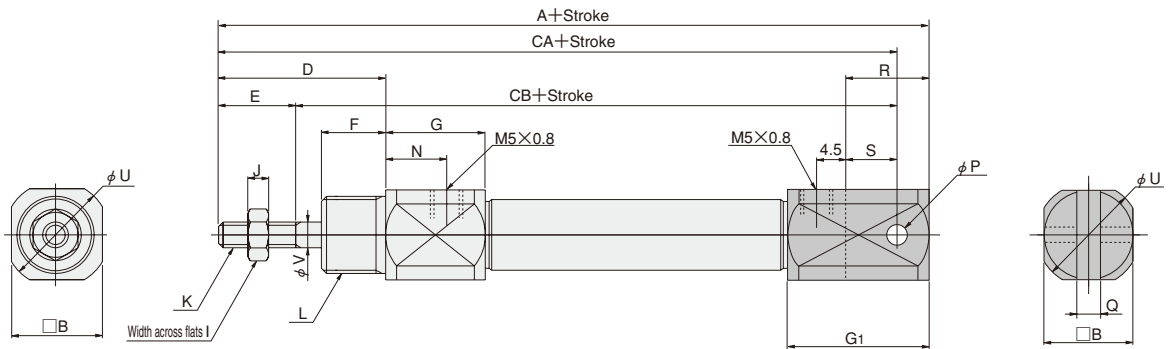

Bore mm [in.]	Code	A	B	D	E	F	G	G <sub>1</sub>	I	J	K	L	N	P	Q	R	S	U	V	CA	CB
10 [0.394]		91	14	26	12	10	14	22	7	3.2	M4×0.7	M12×1	9.5	3.2 <sup>+0.09</sup> <sub>+0.06</sub>	3.2 <sup>+0.2</sup> <sub>+0.1</sub>	13	8	17	4	86	74
16 [0.630]		112	19	32	15	12	22	27	8	4	M5×0.8	M16×1	17.5	5 <sup>+0.09</sup> <sub>+0.06</sub>	6.5 <sup>+0.2</sup> <sub>+0.1</sub>	18	10	22	6	104	89

# MADE TO ORDER PEN CYLINDERS

## Cylinders with Speed Controllers

### Symbol

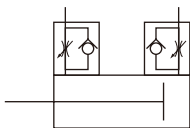

### Specifications

Item	Bore size mm [in.]	10 [0.394]	16 [0.630]
Operation type		Double acting type	
Mounting type		See the table at lower right.	
Media		Air	
Operating pressure range	MPa [psi.]	0.1~0.7 [15~102]	
Proof pressure	MPa [psi.]	1.05[152]	
Operating temperature range	°C [°F]	0~70 [32~158]	
Operating speed range	mm/s [in./sec.]	50~300 [2.0~11.8]	
Cushion		Fixed type (Rubber bumper)	
Lubrication		Not required	
Port size		M5×0.8	

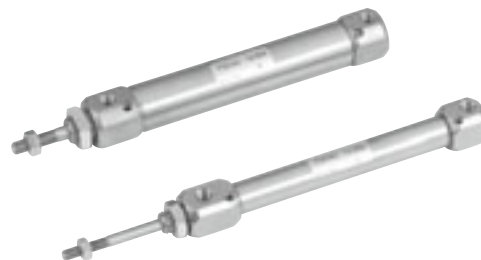

● For delivery, consult us.

### Bore Size and Stroke

Bore size	Standard strokes <sup>Note</sup>	mm [in.]	
		Maximum available stroke	Stroke tolerance
10	15, 30, 45, 60	150	$\begin{matrix} +1.5 \\ 0 \\ [+0.059] \\ 0 \end{matrix}$
16	15, 30, 45, 60	200	$\begin{matrix} +1.5 \\ 0 \\ [+0.059] \\ 0 \end{matrix}$

Note: For non-standard strokes, consult us.

### Mounting type

Mounting type	Name	Remark
1	Double foot type	Included at shipping
1A	Single foot type <sup>Note</sup>	Included at shipping
3	Flange type	Included at shipping
7	Clevis type (with pin)	Assembled and shipped
7-7C	Clevis type with supporting bracket (with pin)	Supporting bracket included at shipping

Note: When the stroke exceeds 60mm, use the double foot type for the foot bracket.

### Order Codes

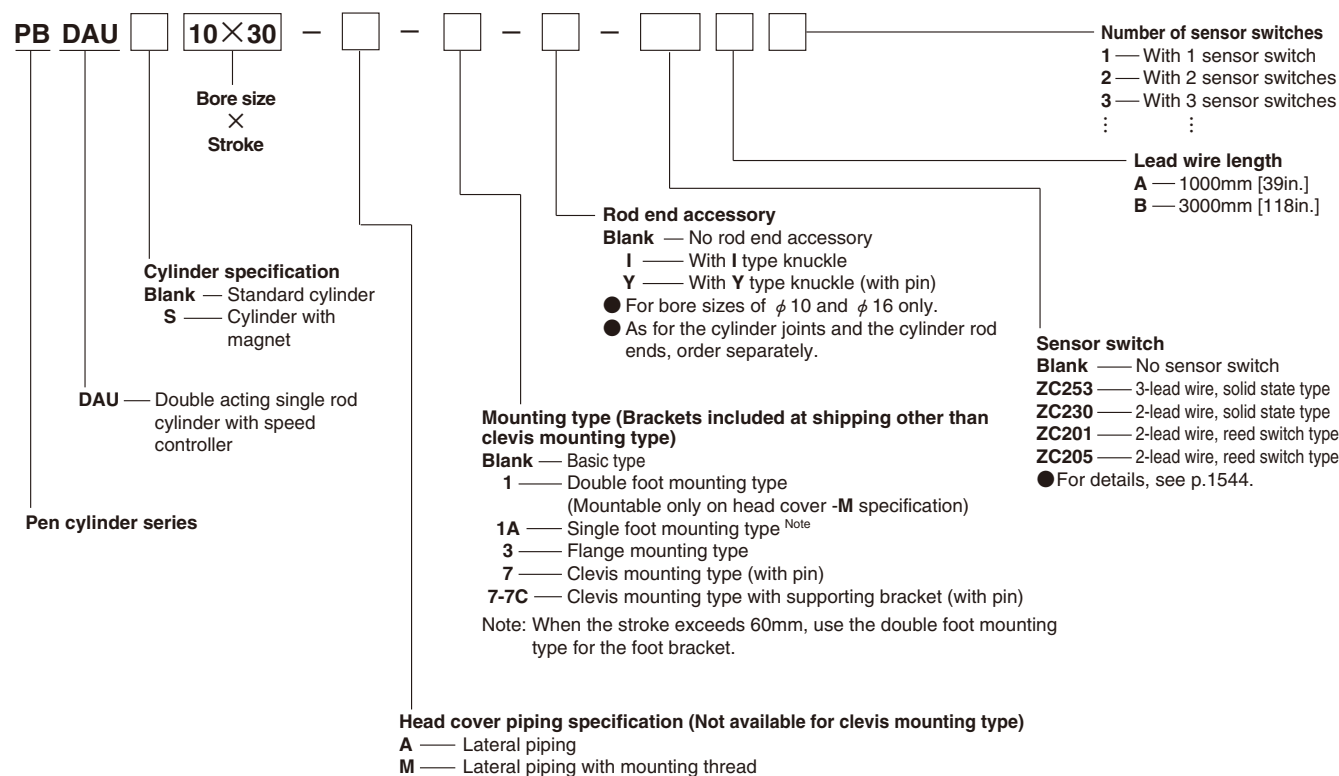

## Inner Construction (cannot be disassembled)

### ● Double acting type

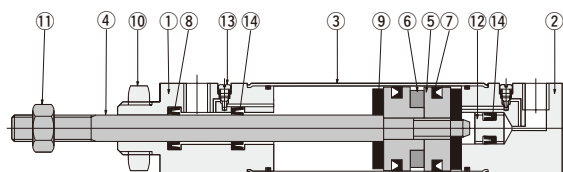

### ● Clevis mounting type (-7)

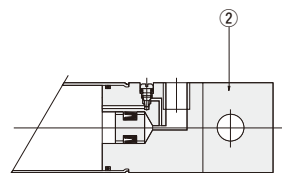

### ● Lateral piping with mounting thread (-M)

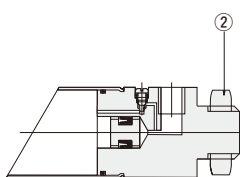

## Major Parts and Materials

No.	Parts	Materials
①	Rod cover	Aluminum alloy (nickel plated)
②	Head cover	
③	Cylinder tube	Stainless steel
④	Piston rod	
⑤	Piston	Aluminum alloy (nickel plated)
⑥	Magnet <sup>Note</sup>	Plastic magnet
⑦	Piston seal	Synthetic rubber (NBR)
⑧	Rod seal	
⑨	Bumper	Mild steel (nickel plated)
⑩	Mounting nut	
⑪	Rod end nut	
⑫	Housing	Brass (nickel plated)
⑬	Needle	Stainless steel
⑭	Check seal	Synthetic rubber (NBR)

Note: For cylinders with magnets. Standard cylinders do not have a built-in magnet for the sensor switch.

## Mass

Bore size mm [in.]	Mounting type	Stroke mm				Additional mass					g [oz.]
						Mounting bracket				Cylinder with magnet	
		15	30	45	60	-1A	-1	-3	-7C		
10 [0.394]	Basic type	33.8 [1.192]	37.5 [1.322]	40.1 [1.414]	44.6 [1.573]	7 [0.25]	14 [0.49]	5 [0.18]	—	1 [0.04]	A : 20 [0.71] B : 50 [1.76]
16 [0.630]		54.5 [1.922]	60 [2.116]	65.3 [2.303]	70 [2.469]	18 [0.63]	36 [1.27]	12 [0.42]	—	2 [0.07]	
10 [0.394]	Clevis mounting type	37.8 [1.333]	41.5 [1.464]	44.1 [1.556]	48.6 [1.714]	—	—	—	20 [0.71]	1 [0.04]	
16 [0.630]		65.5 [2.310]	71 [2.504]	76.3 [2.691]	81 [2.857]	—	—	—	33 [1.16]	2 [0.07]	
10 [0.394]	Lateral piping with mounting thread	36.8 [1.298]	40.5 [1.429]	43.1 [1.520]	47.6 [1.679]	7 [0.25]	14 [0.49]	5 [0.18]	—	1 [0.04]	
16 [0.630]		59.5 [2.099]	65 [2.293]	70.3 [2.480]	75 [2.646]	18 [0.63]	36 [1.27]	12 [0.42]	—	2 [0.07]	

Remark: Includes mounting nut and rod end nut.

## Dimensions of Cylinder with Speed Controllers (mm)

### ● Basic type PBDAU Bore size × Stroke -A

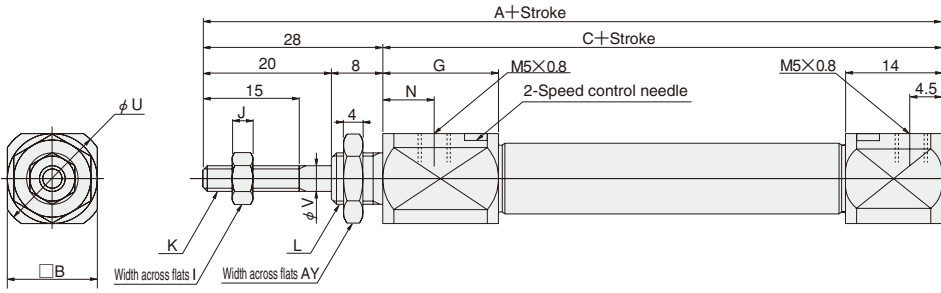

### ● Lateral piping with mounting thread (-M)

#### PBDAU Bore size × Stroke -M

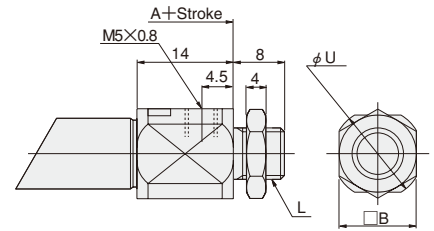

Bore mm [in.]	Code	A	C	B	G	I	J	K	L	N	U	V	AY
10	[0.394]	84	56	14	18	7	3.2	M4×0.7	M8×1	7.5	17	4	12
16	[0.630]	84.5	56.5	17	16.5	8	4	M5×0.8	M10×1	7	19	5	14

### ● Clevis mounting type PBDAU Bore size × Stroke -7

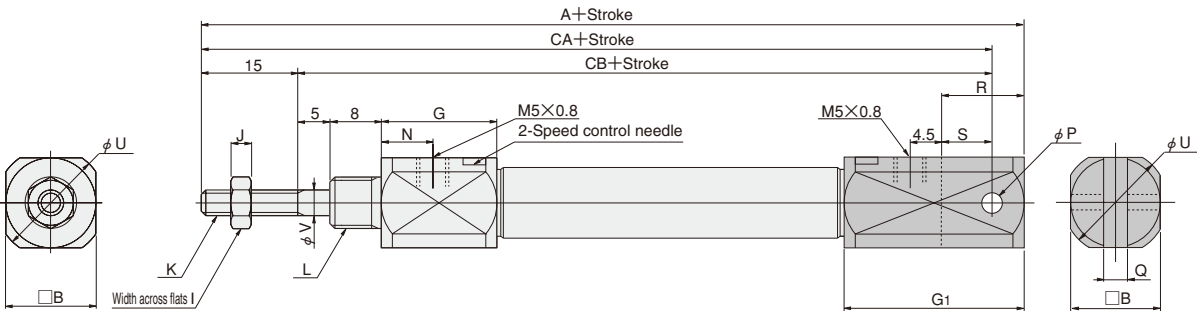

Bore mm [in.]	Code	A	B	G	G <sub>1</sub>	I	J	K	L	N	P	Q	R	S	U	V	CA	CB
10	[0.394]	97	14	18	27	7	3.2	M4×0.7	M8×1	7.5	3.2 <sup>+0.09</sup> <sub>+0.06</sub>	3.2 <sup>+0.2</sup> <sub>+0.1</sub>	13	8	17	4	92	77
16	[0.630]	102.5	17	16.5	32	8	4	M5×0.8	M10×1	7	5 <sup>+0.09</sup> <sub>+0.06</sub>	6.5 <sup>+0.2</sup> <sub>+0.1</sub>	18	10	19	5	94.5	79.5

# SENSOR SWITCHES

Solid State Type, Reed Switch Type

## Symbol

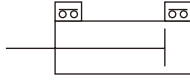

## Order Codes for Sensor Switches

### ● Sensor switches (with mounting band)

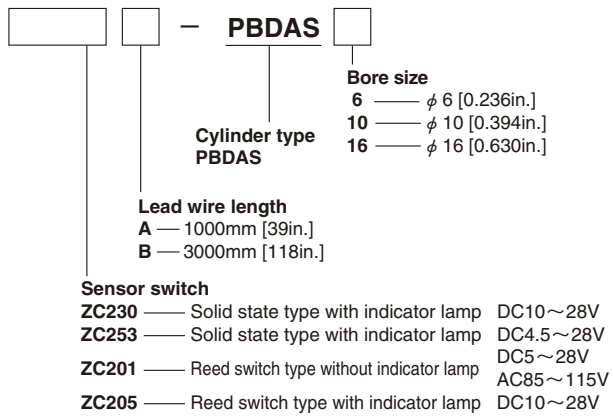

### ● Mounting band only

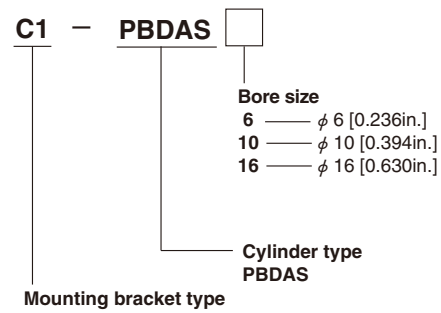

## Minimum Cylinder Strokes When Mounting Sensor Switches

Depending on the sensor switch type and quantity, as well as on the mounting position, the minimum cylinder strokes that allow sensor switch mounting are shown below.

### ● Two pieces mounting

#### ● When mounted in-line

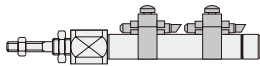

#### ● When mounted in staggered positions

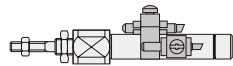

### ● One piece mounting

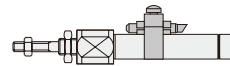

Sensor switch model	2 pcs. mounting		1 pc. mounting
	Along a straight line	In staggered positions	
ZC230□, ZC253□	30	5	5
ZC201□, ZC205□		10	

mm

## Sensor Switch Operating Range, Response Differential, and Maximum Sensing Location

### ● Operating range: $l$

The distance the piston travels in one direction, while the switch is in the ON position.

### ● Response differential: C

The distance between the point where the piston turns the switch ON and the point where the switch is turned OFF as the piston travels in the opposite direction.

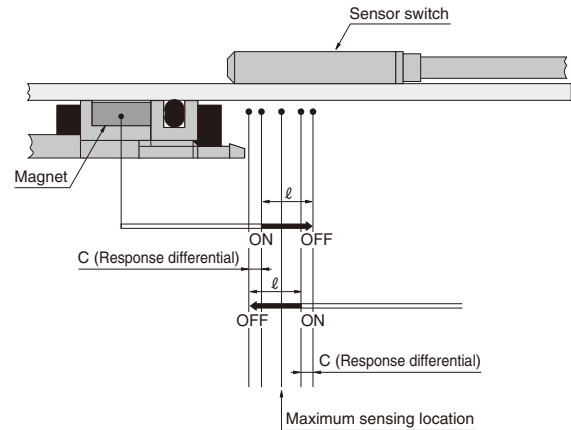

Bore size	ZC230□, ZC253□		ZC201□, ZC205□	
	Operating range	Response differential	Operating range	Response differential
6 [0.236]	1.5~2.5 [0.059~0.098]	0.3 [0.012] or less	4~6 [0.157~0.236]	1.4 [0.055] or less
10 [0.394]	2.0~3.0 [0.079~0.118]	0.3 [0.012] or less	4~6 [0.157~0.236]	1.5 [0.059] or less
16 [0.630]	2.5~3.5 [0.098~0.138]	0.3 [0.012] or less	5~7 [0.197~0.276]	1.8 [0.071] or less

mm [in.]

Note: The operating range and response differential are to be used as reference values.

## Mounting Location of End of Stroke Detection Sensor Switch

When the sensor switch is mounted in the location shown in the diagram (figures in the table are reference values), the magnet comes to the sensor switch's maximum sensing location at the end of the stroke.

### ● Double acting type

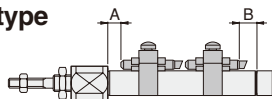

Sensor switch model	Bore size Code	Stroke		
		6 [0.236]	10 [0.394]	16 [0.630]
ZC230□ ZC253□	A	3 [0.118]	3.5 [0.138]	4.5 [0.177]
	B	0.5 [0.020]	-4.5 [-0.177]	-3.5 [-0.138]
ZC201□	A	4.5 [0.177]	5 [0.197]	6 [0.236]
	B	1 [0.039]	-3 [-0.118]	-2 [-0.079]
ZC205□	A	1 [0.039]	1.5 [0.059]	2.5 [0.098]
	B	1.5 [0.059]	-3.5 [-0.138]	-2.5 [-0.098]

mm [in.]

### ● Single acting pull type

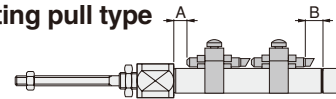

Sensor switch model	Bore size Code	Stroke	Stroke		
			6 [0.236]	10 [0.394]	16 [0.630]
ZC230□ ZC253□	A	—	3 [0.118]	3.5 [0.138]	4.5 [0.177]
	B	0~15 16~30	0.5 [0.020] 5.5 [0.217]	0.5 [0.020] 5.5 [0.217]	1.5 [0.059] 6.5 [0.256]
ZC201□	A	—	4.5 [0.177]	5 [0.197]	6 [0.236]
	B	0~15 16~30	2 [0.079] 7 [0.276]	2 [0.079] 7 [0.276]	3 [0.118] 8 [0.315]
ZC205□	A	—	1 [0.039]	1.5 [0.059]	2.5 [0.098]
	B	0~15 16~30	1.5 [0.059] 6.5 [0.256]	1.5 [0.059] 6.5 [0.256]	2.5 [0.098] 7.5 [0.295]

mm [in.]

### ● Single acting push type

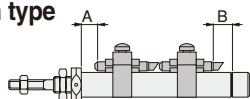

Sensor switch model	Bore size Code	Stroke	Stroke		
			6 [0.236]	10 [0.394]	16 [0.630]
ZC230□ ZC253□	A	0~15	3 [0.118]	8.5 [0.335]	9.5 [0.374]
		16~30	8 [0.315]	13.5 [0.531]	14.5 [0.571]
		31~60	23 [0.906]	23.5 [0.925]	24.5 [0.965]
ZC201□	A	0~15	4.5 [0.177]	10 [0.394]	11 [0.433]
		16~30	9.5 [0.374]	15 [0.591]	16 [0.630]
		31~60	24.5 [0.965]	25 [0.984]	26 [1.024]
ZC205□	A	0~15	1 [0.039]	6.5 [0.256]	7.5 [0.295]
		16~30	6 [0.236]	11.5 [0.453]	12.5 [0.492]
		31~60	21 [0.827]	21.5 [0.846]	22.5 [0.886]
ZC205□	B	—	1.5 [0.059]	-3.5 [-0.138]	-2.5 [-0.098]

mm [in.]

### ● Variable cushion type, linear bearing type, and with speed controller type

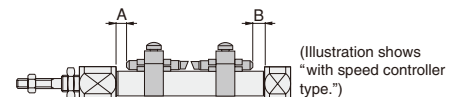

Sensor switch model	Bore size Code	Stroke	
		10 [0.394] <sup>Note</sup>	16 [0.630]
ZC230□ ZC253□	A	2 [0.079]	3 [0.118]
	B	5 [0.197]	6 [0.236]
ZC201□	A	3.5 [0.138]	4.5 [0.177]
	B	6.5 [0.256]	7.5 [0.295]
ZC205□	A	0	1 [0.039]
	B	3 [0.118]	4 [0.157]

mm [in.]

Note: For  $\phi 10$ , always mount so that the indicator lamp is on the cover side and the lead wires are on the inner side, as shown in the diagram.

## Mounting Sensor Switch by Strokes

### ● 5mm stroke

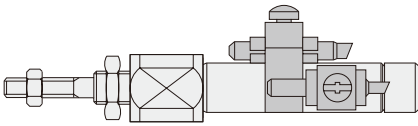

### ● 10mm stroke

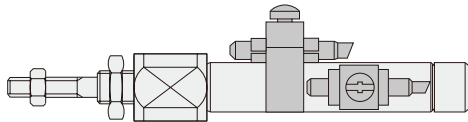

### Position of sensor holder, and how to adjust it

- The sensor holder cannot be installed at the center of the sensor switch when mounting 2 sensor switches on a 5mm stroke cylinder.
- When mounting 2 sensor switches on a 5mm stroke cylinder, loosen the mounting screw and move the sensor switch until the sensor holder is in the position shown in the diagram, and install it in the specified position.
- For 10mm strokes or more, install the sensor holder so that it is approximately in the center of the sensor switch, as shown in the diagram.

## Moving Sensor Switch

- Loosening the mounting screw allows the sensor switch to be moved either along the axial or circumference direction of the cylinder.
- When making fine adjustments of the sensor switch along the axial direction, a very slight loosening of the mounting screw (about one-half turn) is enough to allow the sensor switch to be moved.
- Tighten the mounting screw with a tightening torque of 0.3N·m [2.7in·lbf] or less.

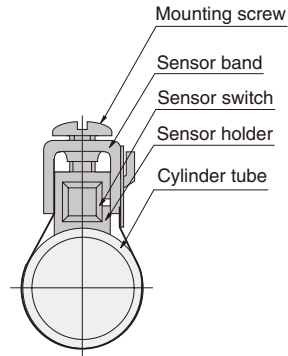

### ● Caution when installing cylinder with sensor switch

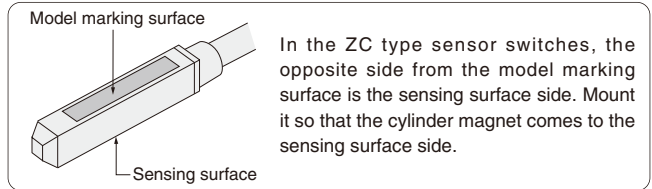

## Dimensions of Sensor Switch Mounting (mm)

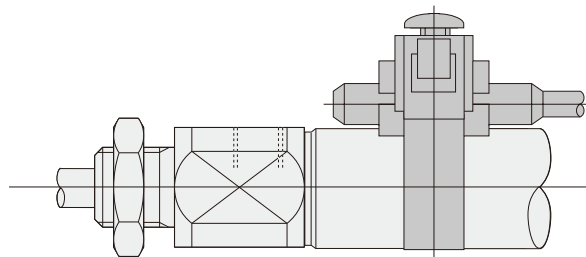
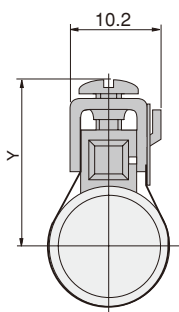

		mm [in.]
Bore	Code	Y
6	[0.236]	(16 [0.630])
10	[0.394]	(18 [0.709])
16	[0.630]	(21 [0.827])



# MOUNTING BRACKETS, ROD END ACCESSORIES

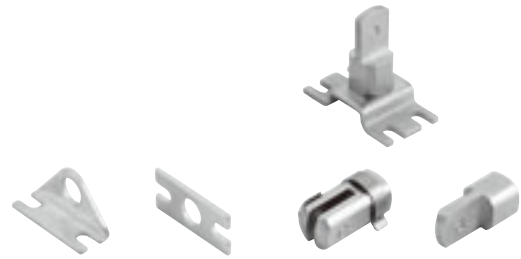

## Dimensions of Mounting Bracket (mm)

### ● Single foot bracket (For the order code, see p. 311.)

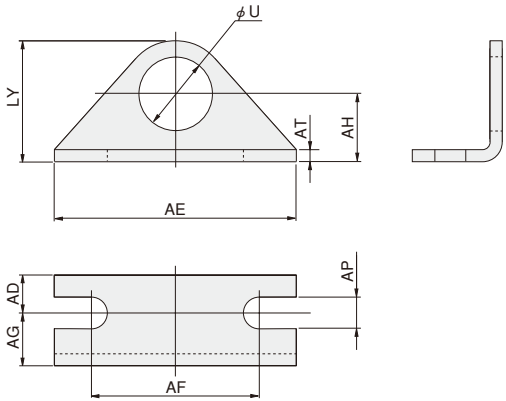

Type	Code Bore mm [in.]	U	AD	AE	AF	AG	AH	AP	AT	LY
Standard	6 [0.236]	6	5	32	22.2	7	9	4.2	1.6	16
	10 [0.394]	8	5	32	22.2	7	9	4.2	1.6	16
	16 [0.630]	10	6	42	29.2	9	14	5.2	2.3	24
Non-rotating	10 [0.394]	10	6	42	29.2	9	14	5.2	2.3	24
	16 [0.630]	12	6	42	29.2	9	14	5.2	2.3	24
Linear bearing	10 [0.394]	12	5	35	25	13	16	4.5	2.3	26
	16 [0.630]	16	6	44	32	13	20	5.5	3.2	33
Clean systems	6 [0.236]	8	5	32	22.2	7	9	4.2	1.6	16
	10 [0.394]	10	6	42	29.2	9	14	5.2	2.3	24
	16 [0.630]	12	6	42	29.2	9	14	5.2	2.3	24

### ● Flange bracket (For the order code, see p. 311.)

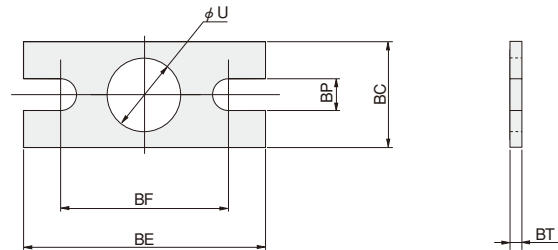

Type	Code Bore mm [in.]	U	BC	BE	BF	BP	BT
Standard	6 [0.236]	6	14	32	22.2	4.2	1.6
	10 [0.394]	8	14	32	22.2	4.2	1.6
	16 [0.630]	10	20	42	29.2	5.2	2.3
Non-rotating	10 [0.394]	10	20	42	29.2	5.2	2.3
	16 [0.630]	12	20	42	29.2	5.2	2.3
Linear bearing	10 [0.394]	12	20	40	30	4.5	2.3
	16 [0.630]	16	26	52	40	5.5	3.2
Clean systems	6 [0.236]	8	14	32	22.2	4.2	1.6
	10 [0.394]	10	20	42	29.2	5.2	2.3
	16 [0.630]	12	20	42	29.2	5.2	2.3

### ● Clevis mount supporting bracket

Order code: 7C-PBDA

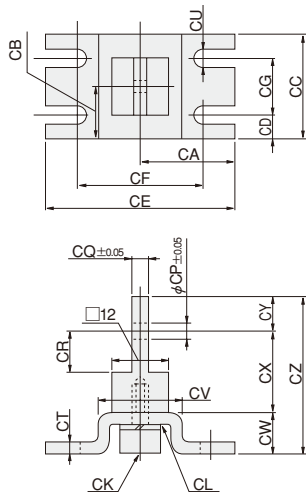

Code Bore mm [in.]	CA	CB	CC	CD	CE	CF	CG	CK (Hexagon socket head bolt)
10 [0.394]	20	11	22	5	40	30.2	12	M4×0.7×10
16 [0.630]	24	14	28	6	48	35.2	16	M5×0.8×10

Code Bore mm [in.]	CL (Spring washer)	CP	CQ	CR	CT	CU	CV	CW	CX	CY	CZ
10 [0.394]	Nominal 4	3.3	3.1	9	2	4.2	18	8	21	7	36
16 [0.630]	Nominal 5	5.1	6.4	14	2.3	5.2	20	10	25	7	42

## Dimensions of Rod End Accessories (mm)

### Y type knuckle

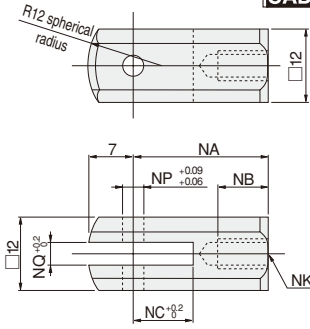

Code	NA	NB	NC	NK	NP	NQ	Mass g [oz.] (with pin)
10 [0.394]	21	8	10	M4×0.7	3.2	3.2	21 [0.74]
16 [0.630]	21	11	10	M5×0.8	5	6.5	15 [0.53]

### I type knuckle

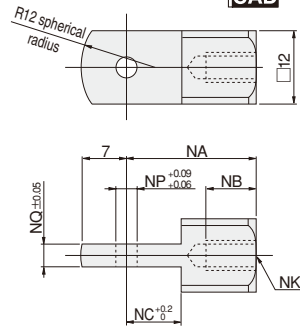

Code	NA	NB	NC	NK	NP	NQ	Mass g [oz.]
10 [0.394]	21	8	9	M4×0.7	3.2	3.1	16 [0.56]
16 [0.630]	25	8	14	M5×0.8	5	6.4	22 [0.78]

## Dimensions of Pin Bracket (mm)

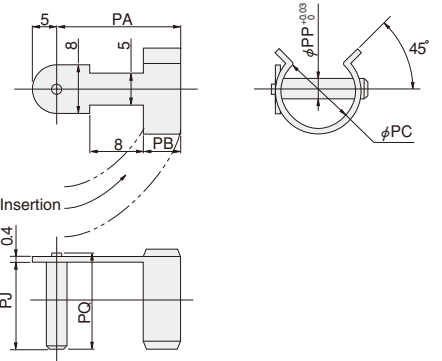

Code	PA	PB	PC	PJ	PP	PQ	Mass g [oz.]
10 [0.394]	17	5	14	13.5	3.2	(15)	2 [0.07]
16 [0.630]	17	5	14	13.5	5	(15)	3 [0.11]
16 [0.630] <sup>※</sup>	19	6	19	19		(20.5)	

Note: ※ shows for clevis mounting bracket use.

## Order Codes for Mounting Brackets and Rod End Accessories

Note: Rod end accessories are not available for clean systems.

### (1) Single foot bracket

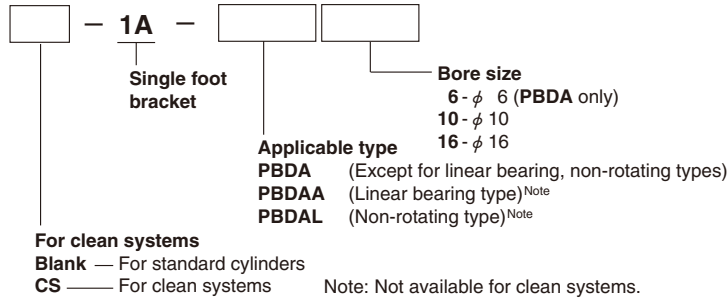

### (5) Y type knuckle

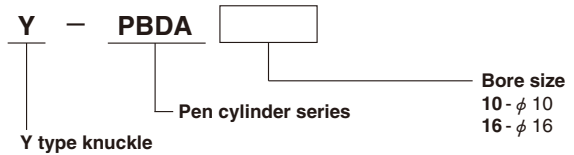

### (2) Double foot bracket (2 foot brackets in 1 set)

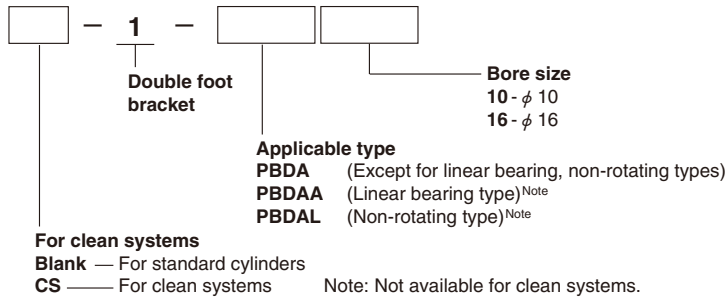

### (6) I type knuckle

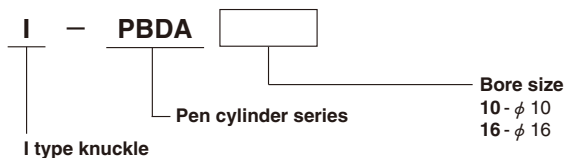

### (3) Flange bracket

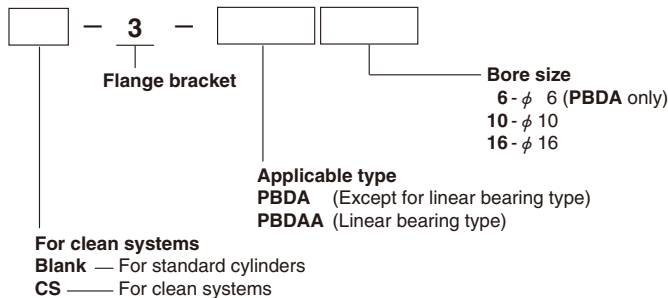

### (7) Pin bracket

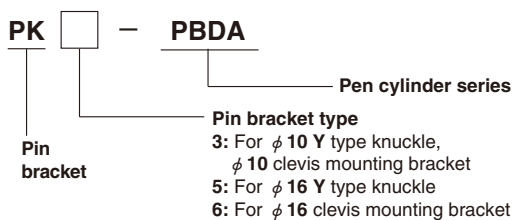

### (4) Clevis mount supporting bracket

