

Rotary Actuator/Vane Type

CRB1 Series

Size: 50, 63, 80, 100

Compact auto switches
can be used! (D-M9□)

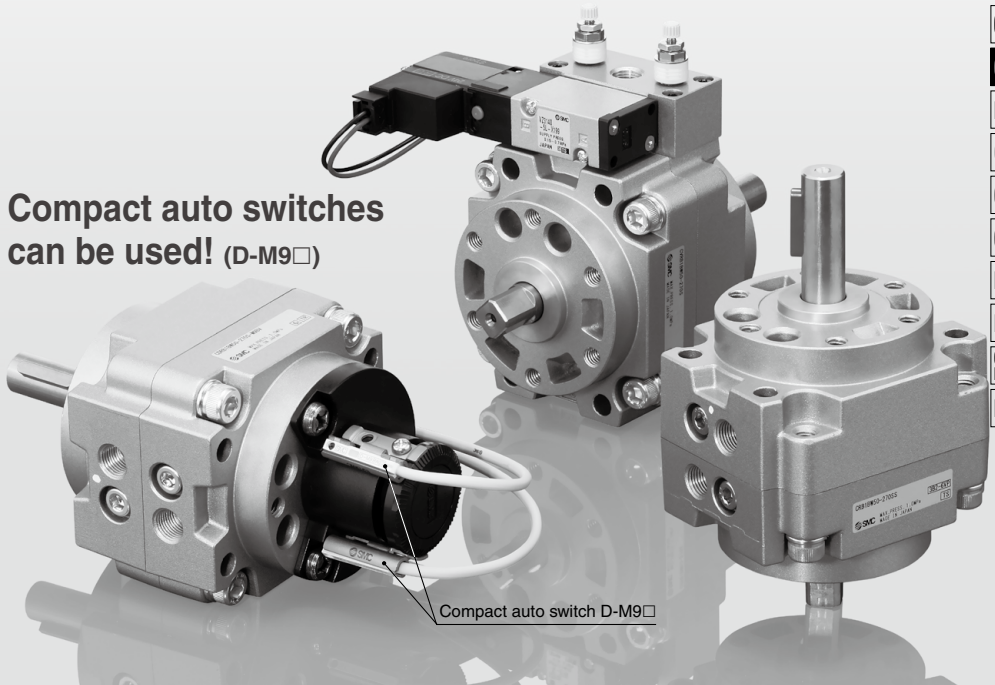

CRB□□

CRB1

MSU

CRJ

CRA1

CRQ2

MSQ

MSZ

CRQ2X
MSQX

MRQ

Compact auto switch D-M9□

Stainless steel specification for main parts

Made to Order

Size: 50, 63, 80, 100

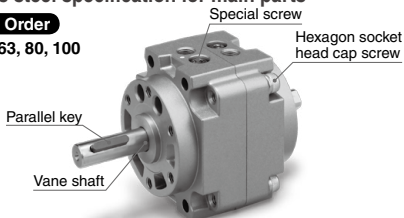

Mounting

Direct mounting

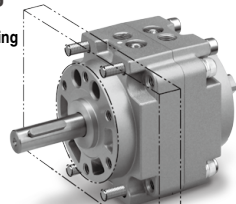

Mounting plate
(Provided by customer)

Two different port locations
(side and axial) are available.

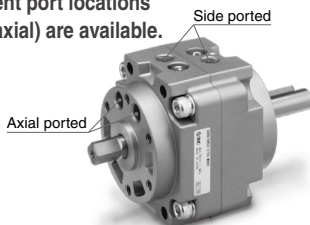

Foot mounting

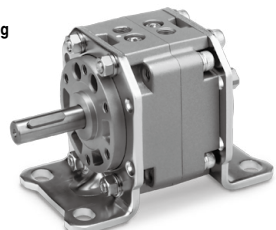

D-□

Basic type
CRB1 Series

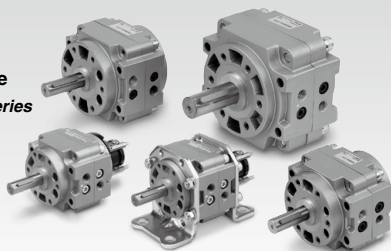

With solenoid valve
CVRB1 Series



Series Variations

		Fluid		Air																
		Size		50				63				80				100				
Vane type	S: Single vane D: Double vane		S		D		S		D		S		D		S		D			
	Port location		Side ported (Nil)	Side ported	Axial ported	Side ported	Axial ported	Side ported	Axial ported	Side ported	Axial ported	Side ported	Axial ported	Side ported	Axial ported	Side ported	Axial ported			
Standard	Rotating angle	90°		•	•	•	•	•	•	•	•	•	•	•	•	•	•	•		
		180°		•	•	•	•	•	•	•	•	•	•	•	•	•	•	•	•	
		270°		•	•	•	•	•	•	•	•	•	•	•	•	•	•	•	•	
		Semi-standard	100°		•	•	•	•	•	•	•	•	•	•	•	•	•	•	•	•
			190°		•	•	•	•	•	•	•	•	•	•	•	•	•	•	•	•
			280°		•	•	•	•	•	•	•	•	•	•	•	•	•	•	•	•
Shaft type	Double shaft		W	•	•	•	•	•	•	•	•	•	•	•	•	•	•	•		
Cushion	Rubber bumper		•	•	•	•	•	•	•	•	•	•	•	•	•	•	•	•		
Variations	Basic type		•	•	•	•	•	•	•	•	•	•	•	•	•	•	•	•		
	With auto switch		•	•	•	•	•	•	•	•	•	•	•	•	•	•	•	•	•	
	With One-touch fittings		•	•	•	•	•	•	•	•	•	•	•	•	•	•	•	•	•	
	Clean series	10-		•	•	•	•	•	•	•	•	•	•	•	•	•	•	•	•	
	Copper-free and fluorine-free	20-		•	•	•	•	•	•	•	•	•	•	•	•	•	•	•	•	
With solenoid valve	CVRB1		•	•	•	•	•	•	•	•	•	•	•	•	•	•	•	•		
Option	Mounting	With foot bracket		L	•	•	•	•	•	•	•	•	•	•	•	•	•	•		
Made to Order	Material	Stainless steel specification for main parts		•	•	•	•	•	•	•	•	•	•	•	•	•	•	•		
		Shaft type	Double shaft type	Double shaft (Long shaft with four chamfers)		J	•	•	•	•	•	•	•	•	•	•	•	•	•	
	Double shaft with four chamfers			Z	•	•	•	•	•	•	•	•	•	•	•	•	•	•		
	Double shaft key		Y	•	•	•	•	•	•	•	•	•	•	•	•	•	•	•		
	Double round shaft		K	•	•	•	•	•	•	•	•	•	•	•	•	•	•	•		
	Single shaft type		Single shaft key		S	•	•	•	•	•	•	•	•	•	•	•	•	•	•	•
		Single round shaft		T	•	•	•	•	•	•	•	•	•	•	•	•	•	•	•	
		Single shaft with four chamfers		X	•	•	•	•	•	•	•	•	•	•	•	•	•	•	•	
	Pattern	Shaft pattern		•	•	•	•	•	•	•	•	•	•	•	•	•	•	•	•	
		Rotation pattern		•	•	•	•	•	•	•	•	•	•	•	•	•	•	•	•	•

CONTENTS

Vane Type Rotary Actuator *CRB1 Series*

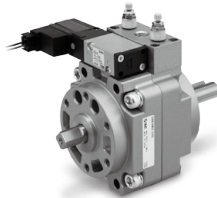
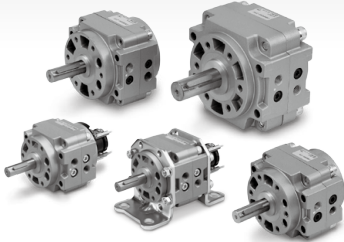

● Vane Type Rotary Actuator *CRB1 Series*

How to Order	Page 110
Specifications	Page 111
Construction	Page 116
Dimensions	Page 117

● Rotary Actuator with Solenoid Valve *CVRB1 Series*

How to Order	Page 121
Specifications	Page 122
Dimensions	Page 122

● Simple Specials

Shaft Pattern Sequencing I -XA1 to -XA24	Page 124
Shaft Pattern Sequencing II -XA31 to -XA60	Page 127

● Made to Order

Page 133

● Auto Switch Mounting

Page 135

CRB1
CRB1
MSU
CRJ
CRA1
CRQ2
MSQ
MSZ
CRQ2X MSQX
MRQ

D-□

Vane Type Rotary Actuator

CRB1 Series

Size: 50, 63, 80, 100

How to Order

Basic type

CRB1 **B** **W** **80** - **90** **S** □

With auto switch

CDRB1 **B** **W** **80** - **90** **S** □ - **M9B** **L** □

Shaft type

W Double shaft (Long shaft key & Four chamfers)

Rotating angle

Classification	Symbol	Single vane	Double vane
Standard	90	90°	90°
	180	180°	—
	270	270°	—
Semi-standard	100	100°	100°
	190	190°	—
	280	280°	—

Mounting

B	Basic
L	Foot

Refer to Table (1) below when foot bracket assembly is required separately.

Table (1): Foot Bracket Assembly Part Number

Model	Assembly part no.
CRB1LW50	P411020-5
CRB1LW63	P411030-5
CRB1LW80	P411040-5
CRB1LW100	P411050-5

Size

50
63
80
100

Vane type

S	Single vane
D	Double vane

Connecting port location

Nil	Side ported
E	Axial ported

Auto switch

Nil	Without auto switch (Built-in magnet)
M	Without D-M9 type auto switch (Built-in magnet)

* For applicable auto switch model, refer to the table below.

** The operating range and hysteresis of the D-M9□ are different from those of the other auto switches. For details, refer to page 135.

Made to Order or Port thread type

Refer to pages 124 to 126, 133 and 134 for details about Made to Order specifications.

Nil	Rc
-XF*	G
-XN*	NPT

* Combination with Made to Order is not available.

Number of auto switches

S	1 pc.*
Nil	2 pcs.**

* S: A right-hand auto switch is shipped.

** Nil: A right-hand switch and a left-hand switch are shipped.

Electrical entry/Lead wire length

Nil	Grommet/Lead wire: 0.5 m
M	Grommet/Lead wire: 1 m
L	Grommet/Lead wire: 3 m
CN	Connector/Without lead wire
C	Connector/Lead wire: 0.5 m
CL	Connector/Lead wire: 3 m

* Connectors are available only for the R73, R80, T79.

** Lead wire with connector part nos.
D-LC05: Lead wire 0.5 m
D-LC30: Lead wire 3 m
D-LC50: Lead wire 5 m

Applicable Auto Switches/Refer to pages 797 to 850 for further information on auto switches.

Type	Special function	Electrical entry	Indicator light	Wiring (Output)	Load voltage		Auto switch model		Lead wire type	Lead wire length [m]					Pre-wired connector	Applicable load		
					DC	AC	Perpendicular	In-line		0.5 (Nil)	1 (M)	3 (L)	5 (Z)	None (N)				
																	M9NV	M9N
Solid state auto switch	—	Grommet	Yes	3-wire (NPN)	24 V	5 V, 12 V	—	M9NV	M9N	Oilproof heavy-duty cord	●	●	○	—	○	IC circuit		
				3-wire (PNP)				M9PV	M9P		●	●	○	—	○			
				2-wire				M9BV	M9B		●	●	○	—	○		IC circuit	
				3-wire (NPN)				—	S79		●	●	○	—	○			
				3-wire (PNP)				—	S7P		●	●	○	—	○			
				2-wire				—	T79		●	●	○	—	○			
Reed auto switch	—	Connector	Yes	2-wire	24 V	—	100 V	—	R73	Oilproof heavy-duty cord	●	●	○	—	○	—		
								—	R73C		●	●	○	—	○			
								48 V, 100 V	—		R80	●	●	○	—		○	IC circuit
								—	—		R80C	●	●	○	—		○	
								—	24 V or less		—	●	●	○	—		○	
								—	24 V or less		—	●	●	○	—		○	

* Lead wire length symbols: 0.5 m Nil (Example) R73C
3 m L (Example) R73CL
5 m Z (Example) R73CZ
None N (Example) R73CN

* Solid state auto switches marked with "○" are produced upon receipt of order.

- Excellent reliability and durability.
The use of bearings to support thrust and radial loads improves reliability and durability.
- The body of the rotary actuator can be mounted directly.
- Two different port locations (side and axial) are available.

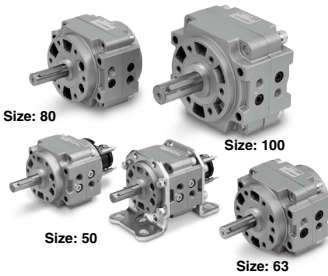

Symbol



Refer to pages 135 to 137 for actuators with auto switches.

- Auto switch unit and switch block unit
- Operating range and hysteresis
- How to change the auto switch detecting position
- Auto switch mounting
- Auto switch adjustment



Made to Order
(For details, refer to pages 124 to 126, 133 and 134.)

Symbol	Description
XA1 to XA24	Shaft type pattern
XC1	Addition of connection port
XC4	Change of rotating angle
XC5	Change of rotating angle
XC6	Change of rotating angle
XC7	Reversed shaft
XC26	Change of rotating angle
XC27	Change of rotation range and direction
XC30	Fluorine grease

Specifications

Size		50	63	80	100	50	63	80	100
Vane type		Single vane (S)				Double vane (D)			
Rotating angle	Standard	90°±, 180°±, 270°±				90°±			
	Semi-standard	100°±, 190°±, 280°±				100°±			
Fluid		Air (Non-lube)							
Proof pressure		1.5 MPa							
Ambient and fluid temperature		5 to 60°C							
Max. operating pressure		1.0 MPa							
Min. operating pressure		0.15 MPa							
Rotation time adjustment range		0.1 to 1 s/90°							
Allowable kinetic energy		0.082 J	0.12 J	0.398 J	0.6 J	0.112 J	0.16 J	0.54 J	0.811 J
Shaft load	Allowable radial load	245 N	390 N	490 N	588 N	245 N	390 N	490 N	588 N
	Allowable thrust load	196 N	340 N	490 N	539 N	196 N	340 N	490 N	539 N
Bearing		Bearing							
Port location		Side ported or Axial ported							
Port size	Side ported	1/8		1/4		1/8		1/4	
	Axial ported	1/8		1/4		1/8		1/4	
Mounting		Basic, Foot							

For details on how to calculate the moment of inertia, required torque, kinetic energy, etc., refer to the **"Rotary Actuators Model Selection."**
Model selection software is available. For details, refer to the **"Model Selection Software"** section on the SMC website.

Volume

Classification	Rotating angle	Single vane (S)				Double vane (D)			
		50	63	80	100	50	63	80	100
		Standard	90°	30	70	88	186	48	98
Standard	180°	49	94	138	281	—	—	—	—
	270°	66	118	188	376	—	—	—	—
	Semi-standard	100°	32	73	93	197	52	104	146
Semi-standard	190°	51	97	143	292	—	—	—	—
	280°	68	121	193	387	—	—	—	—

Weight

Model	Rotating angle	Single vane (S)				Double vane (D)			
		50	63	80	100	50	63	80	100
		Main body	90°	810	1365	2070	3990	830	1410
Main body	180°	790	1330	2010	3880	—	—	—	—
	270°	770	1290	1950	3760	—	—	—	—
	100°	808	1360	2065	3980	822	1400	2100	4100
	190°	788	1325	2005	3870	—	—	—	—
	280°	766	1285	1940	3735	—	—	—	—
Auto switch unit + 2 auto switches		65	85	95	165	65	85	95	165
Foot bracket assembly		384	785	993	1722	384	785	993	1722

Mounting Bracket Assembly Part No.

Model		Foot bracket assembly part number	Description
Basic type	With auto switch		
CRB1LW50	CDRB1LW50	P411020-5	· 2 foot brackets · 8 mounting bolts · 8 mounting nuts · 8 washers
CRB1LW63	CDRB1LW63	P411030-5	
CRB1LW80	CDRB1LW80	P411040-5	
CRB1LW100	CDRB1LW100	P411050-5	

* Refer to page 119 for detailed dimensions.

CRB1 Series

Effective Output

Size: 50

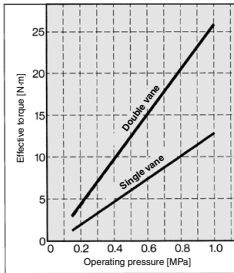

Size: 63

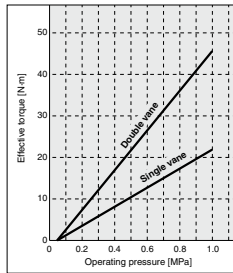

Size: 80

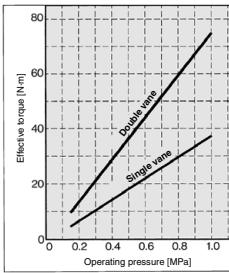

Size: 100

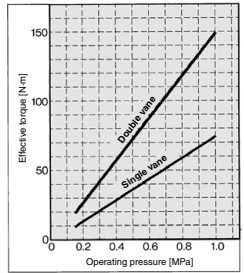

Key Position and Rotation Range (Top View from Long Shaft Side)

Key positions in the figures below show the intermediate rotation position when A or B port is pressurized.

	Single vane type			Double vane type
	90°	180°	270°	90°
Standard				
Semi-standard				

Direct Mounting of Body

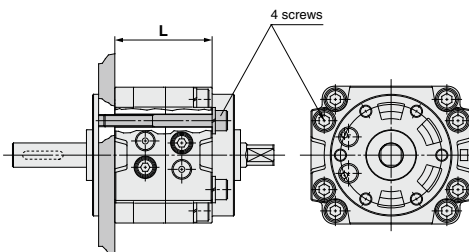

Reference Screw Size

Size	L	Screw
50	48	M 6
63	52	M 8
80	60	M 8
100	80	M10

With One-touch Fittings

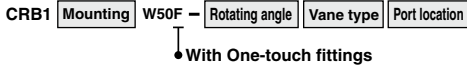

With One-touch fittings facilitate the piping work and greatly reduce the installation space.

Specifications

Vane type	Single vane	Double vane
Size	50	
Operating pressure range [MPa]	0.15 to 1.0	
Speed regulation range [s/90°]	0.1 to 1	
Port location	Side ported or Axial ported	
Piping	With One-touch fittings	
Mounting	Basic, Foot	
Variations	Basic type, With auto switch	

Applicable Tubing and Size

Applicable tubing O.D./I.D [mm]	$\phi 6/\phi 4$
Applicable tubing material	Nylon, Soft nylon, Polyurethane

Refer to page 120 for external dimensions.

Clean Series

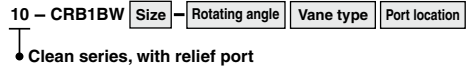

The double-seal construction of the actuator shaft section of these series to channel exhaust through the relief ports directly to the outside of a clean room environment allows operation of these cylinders in a class 100 clean room.

Specifications

Vane type	Single/Double vane	
Size	50	63
Operating pressure range [MPa]	0.15 to 1.0	
Speed regulation range [s/90°]	0.1 to 1	
Port location	Side ported or Axial ported	
Piping	Screw-in type	
Relief port size	M5 x 0.8	
Mounting	Basic	
Variations	Basic type, With auto switch	
Allowable kinetic energy	0.029 J	0.042 J

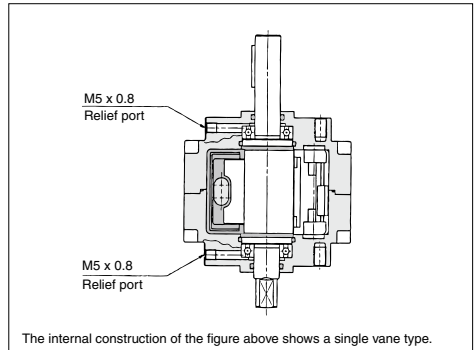

CRB□2

CRB1

MSU

CRJ

CRA1

CRQ2

MSQ

MSZ

CRQ2X
MSQX

MRQ

D-□

CRB1 Series

Stainless Steel Specification for Main Parts

CDRB1 Mounting W Size — Rotating angle Vane type Port location S

● Auto switch

Nil	Basic type
D	With auto switch (With switch unit)

● Stainless steel specification for main parts

Specifications

Vane type	Single/Double vane			
Size	50	63	80	100
Operating pressure range [MPa]	0.15 to 1.0			
Speed regulation range [s/90°]	0.1 to 1			
Port location	Side ported or Axial ported			
Piping	Screw-in type			
Mounting	Basic, Foot			
Variations	Basic type, With auto switch			
Allowable kinetic energy	0.029 J	0.042 J	0.142 J	0.212 J

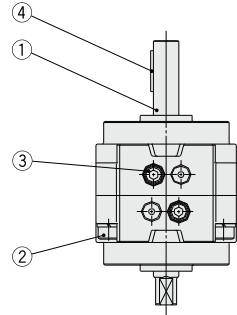

Stainless Steel Parts

	Description
1	Vane shaft
2	Hexagon socket head cap screw
3	Special screw
4	Parallel key

* Individual part cannot be shipped.

Rotary Actuator: Replaceable Shaft

A shaft can be replaced with a different shaft type except for standard shaft type (W).

Without auto switch **CRB1B J** Size — Rotating angle Vane type Port location — Made to Order

Shaft type

J	Double shaft (Long shaft with four chamfers)
K	Double round shaft
S	Single shaft key
T	Single round shaft
X	Single shaft with four chamfers
Y	Double shaft key
Z	Double shaft with four chamfers

Made to Order

Symbol	Description
XA31 to XA60	Shaft type pattern
XC1	Addition of connection port
XC4	Change of rotating angle
XC5	Change of rotating angle
XC6	Change of rotating angle
XC7	Reversed shaft
XC26	Change of rotating angle
XC27	Change of rotation range and direction
XC30	Fluorine grease

* Refer to pages 127 to 134 for details.

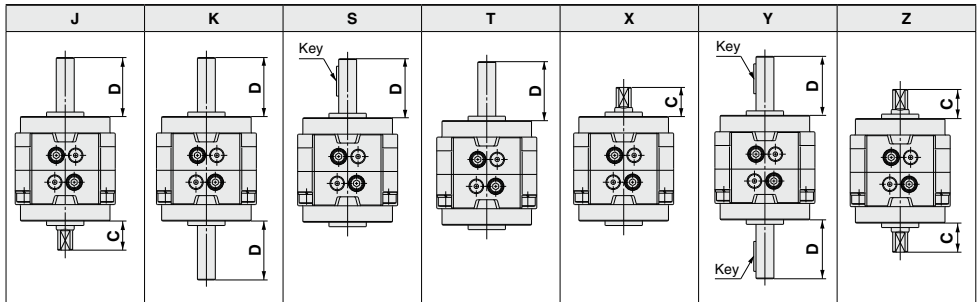

[mm]

Size	C	D
50	19.5	39.5
63	21	45
80	23.5	53.5
100	30	65

Note) Dimensions of the shaft and key groove are the same as the standard.
(Dimension parts different from the standard conform to the general tolerance.)

With auto switch **CDRB1B J** Size — Rotating angle Vane type Port location — Made to Order

With auto switch

Shaft type

J	Double shaft (Long shaft with four chamfers)
Z	Double shaft with four chamfers

Made to Order

Symbol	Description
XA31 to XA60	Shaft type pattern
XC1	Addition of connection port
XC4	Change of rotating angle
XC5	Change of rotating angle
XC6	Change of rotating angle
XC7	Reversed shaft
XC26	Change of rotating angle
XC27	Change of rotation range and direction
XC30	Fluorine grease

The above may not be selected when the product comes with an auto switch. Refer to pages 127 to 134 for details.

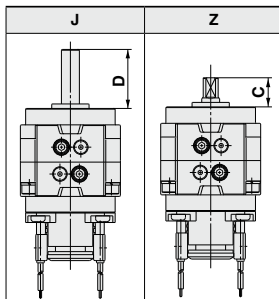

[mm]

Size	C	D
50	19.5	39.5
63	21	45
80	23.5	53.5
100	30	65

Note) Dimensions of the shaft and key groove are the same as the standard.
(Dimension parts different from the standard conform to the general tolerance.)

CRB1 Series

Construction

Basic type (Keys in the figures below show the intermediate rotation position.)

For 270° (Top view from long shaft side)

Single vane

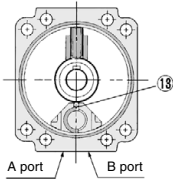

For 180° (Top view from long shaft side)

Single vane

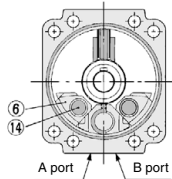

For 90° (Top view from long shaft side)

Single vane

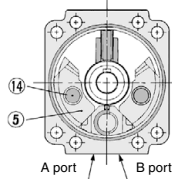

For 90° (Top view from long shaft side)

Double vane

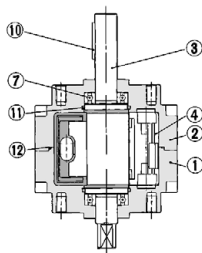
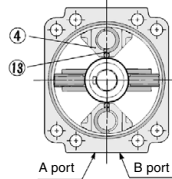

(Long shaft side)

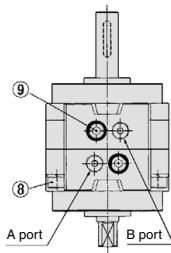

(Short shaft side)

With auto switch

(Keys in the figures below show the actuator for 180° when A port is pressurized.)

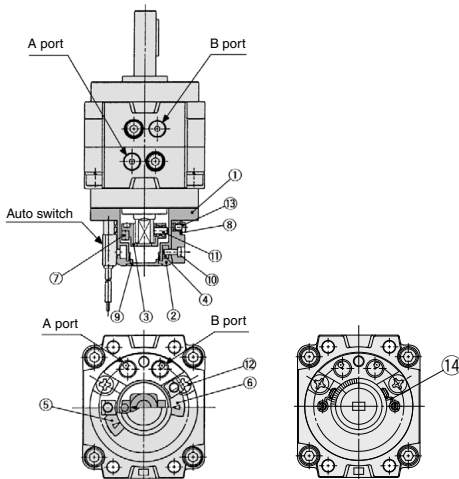

D-M9□

Component Parts

No.	Description	Material	Note
1	Body (A)	Aluminum alloy	Painted
2	Body (B)	Aluminum alloy	Painted
3	Vane shaft	Carbon steel*	
4	Stopper	Aluminum alloy	
5	Stopper	Resin	For 90°
6	Stopper	Resin	For 180°
7	Bearing	Bearing steel	
8	Hexagon socket head cap screw (with washer)	Chrome molybdenum steel	
9	Special screw	Chrome molybdenum steel	
10	Parallel key	Carbon steel	
11	O-ring	NBR	
12	O-ring	NBR	Special O-ring
13	Stopper seal	NBR	Special seal
14	Holding rubber	NBR	

* Individual part cannot be shipped.

* The material is chrome molybdenum steel for double vane type.

Component Parts

No.	Description	Material	Note
1	Cover (A)	Resin	
2	Cover (B)	Resin	
3	Magnet lever	Resin	
4	Holding block	Stainless steel	
5	Switch block (A)	Resin	
6	Switch block (B)	Resin	
7	Magnet	—	
8	Arm	Stainless steel	
9	Rubber cap	NBR	
10	Cross recessed round head screw	Stainless steel	
11	Hexagon socket head set screw	Stainless steel	
12	Cross recessed round head screw	Chrome molybdenum steel	For size 50, 63, 80
13	Hexagon socket head cap screw	Chrome molybdenum steel	For size 100
14	Cross recessed round head screw	Stainless steel	
14	Switch holder	Stainless steel	

* Individual part cannot be shipped. Please purchase the whole unit. (Refer to page 135.)

Dimensions: 50, 63, 80, 100

Single vane type/Double vane type
CRB1BW□-□S/D
<Port location: Side ported>

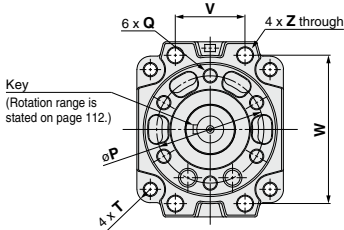

Key Dimensions

Key dimension			
	b (h9)	h (h9)	L
Size			
50	4 ⁰ _{-0.030}	4 ⁰ _{-0.030}	20
63	5 ⁰ _{-0.030}	5 ⁰ _{-0.030}	25
80	5 ⁰ _{-0.030}	5 ⁰ _{-0.030}	36
100	7 ⁰ _{-0.036}	7 ⁰ _{-0.036}	40

Axial ported (Port location): CRB1BW□-□SE, CRB1BW□-□DE

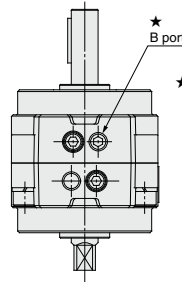
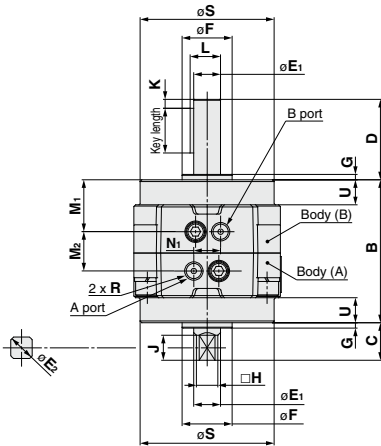

★ If B port of Body (B) is machined, the port is plugged with Rc1/8.

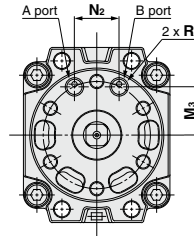
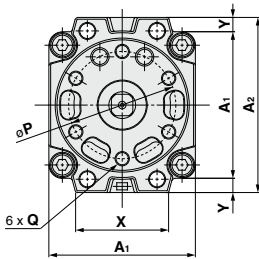

Size	A1	A2	B	C	D	E1 (g6)	E2 (h9)	F (h9)	G	H	J	K	L	M1	M2	M3	N1	N2	P	Q	R (°)	S	T	U	V	W	X	Y	Z
50	67	78	70	19.5	39.5	12 ^{-0.006} _{-0.017}	11.9 ⁰ _{-0.043}	25 ⁰ _{-0.032}	3	10	13	5	13.5	26	18	21	14	18	50	M6 x 1 depth 9	1/8	60	R6	11	34	66	46	5.5	6.5
63	82	98	80	21	45	15 ^{-0.006} _{-0.017}	14.9 ⁰ _{-0.043}	28 ⁰ _{-0.032}	3	12	14	5	17	29	22	27	15	25	60	M8 x 1.25 depth 10	1/8	75	P7.5	14	39	83	52	8	9
80	95	110	90	23.5	53.5	17 ^{-0.006} _{-0.017}	16.9 ⁰ _{-0.043}	30 ⁰ _{-0.032}	3	13	16	5	19	30	30	29	20	30	70	M8 x 1.25 depth 12	1/4	88	R8	15	48	94	63	7.5	9
100	125	140	103	30	65	25 ^{-0.007} _{-0.020}	24.9 ⁰ _{-0.052}	45 ⁰ _{-0.062}	4	19	22	5	28	35.5	32	38	24	38	80	M10 x 1.5 depth 13	1/4	108	R11	11.5	60	120	78	7.5	11

* For single vane type: Above figures show actuators for 180° when B port is pressurized.
 * For double vane type: Figures above show the intermediate rotation position when the A or B port is pressurized.
 * In addition to Rc, G and NPT are also available for connection ports.

CRB1 Series

Dimensions: 50, 63, 80, 100 (With auto switch)

Single vane type/Double vane type

CDRB1BW□-□S/D

<Port location: Side ported>

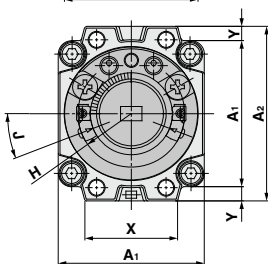
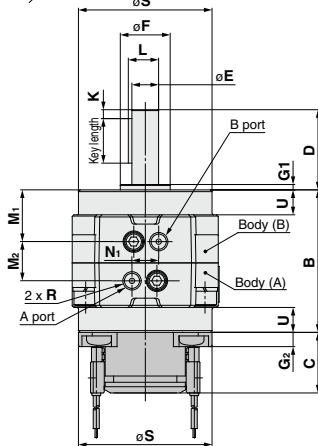
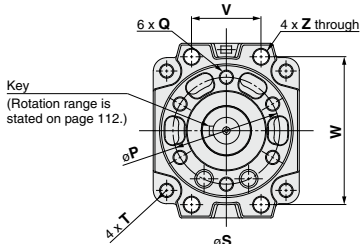

Axial ported (Port location): CDRB1BW□-□SE, CDRB1BW□-□DE

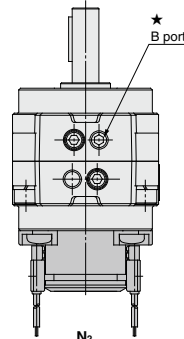

★ If B port of Body (B) is machined, the port is plugged with Rc1/8.

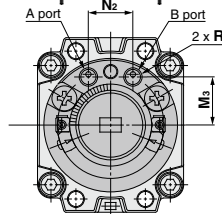

D-M9□

Key Dimensions

Key dimension			
	b (h9)	h (h9)	L
Size			
50	4 ⁰ _{-0.030}	4 ⁰ _{-0.030}	20
63	5 ⁰ _{-0.030}	5 ⁰ _{-0.030}	25
80	5 ⁰ _{-0.030}	5 ⁰ _{-0.030}	36
100	7 ⁰ _{-0.036}	7 ⁰ _{-0.036}	40

Size	A1	A2	B	C	D	E (g6)	F (h9)	G1	G2	H (R)	J	K	L	M1	M2	M3	N1	N2	P	Q	R (+)	S	T	U	V	W	X	Y	Z
50	67	78	70	32	39.5	12 ^{-0.006} _{-0.017}	25 ⁰ _{-0.052}	3	6.5	R22.5	32.5	5	13.5	26	18	21	14	18	50	M6 x 1 depth 9	1/8	60	P6	11	34	66	46	5.5	6.5
63	82	98	80	34	45	15 ^{-0.006} _{-0.017}	28 ⁰ _{-0.052}	3	8	R30	21	5	17	29	22	27	15	25	60	M8 x 1.25 depth 10	1/8	75	R7.5	14	39	83	52	8	9
80	95	110	90	34	53.5	17 ^{-0.005} _{-0.017}	30 ⁰ _{-0.052}	3	8	R30	21	5	19	30	30	29	20	30	70	M8 x 1.25 depth 12	1/4	88	P8	15	48	94	63	7.5	9
100	125	140	103	39	65	25 ^{-0.007} _{-0.020}	45 ⁰ _{-0.062}	4	13	R30	21	5	28	35.5	32	38	24	38	80	M10 x 1.5 depth 13	1/4	108	P11	11.5	60	120	78	7.5	11

* For single vane type: Above figures show actuators for 180° when B port is pressurized.

* For double vane type: Figures above show the intermediate rotation position when the A or B port is pressurized.

* In addition to Rc, G and NPT are also available for connection ports.

Dimensions

Option: Foot bracket

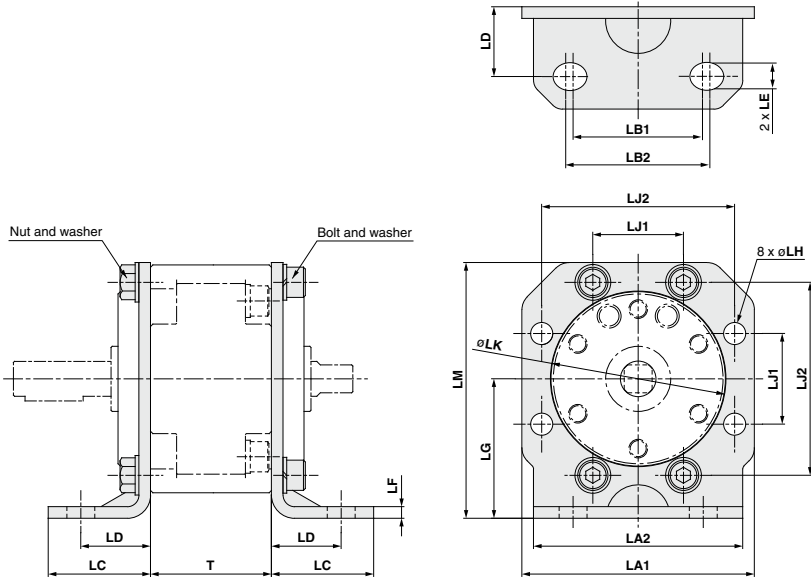

CRB□2
CRB1
MSU
CRJ
CRA1
CRQ2
MSQ
MSZ
CRQ2X
MSQX
MRQ

Size	Foot bracket assembly part number	LA1	LA2	LB1	LB2	LC	LD	LE	LF	LG	LH	LJ1	LJ2	LK	LM	T
50	P411020-5	78	70	45	50	36	25.5	ø10	4.5	45	7.5	34	66	60.5	84	48
63	P411030-5	100	90	56	60	44	30	ø12	5	60	9.5	39	83	75.5	110	52
80	P411040-5	111	100	63	70	46	32	ø12	6	65	9.5	48	94	88.5	120.5	60
100	P411050-5	141	126	80	90	55	39.5	ø14	6	80	11.5	60	120	108.5	150.5	80

Note 1) The foot bracket (with bolt, nut, and washer) is not mounted on the actuator at the time of shipment.

Note 2) The foot bracket can be mounted on the rotary actuator at 90° intervals.

Note 3) Refer to the foot bracket assembly part number in the table at right when foot bracket assembly is required separately.

Model		Foot bracket assembly part number
Basic type	With auto switch	
CRB1LW50	CDRB1LW50	P411020-5
CRB1LW63	CDRB1LW63	P411030-5
CRB1LW80	CDRB1LW80	P411040-5
CRB1LW100	CDRB1LW100	P411050-5

D-□

CRB1 Series

With One-touch Fittings: 50

Basic type

CRB1□W50F-□□

<Port location: Side ported>

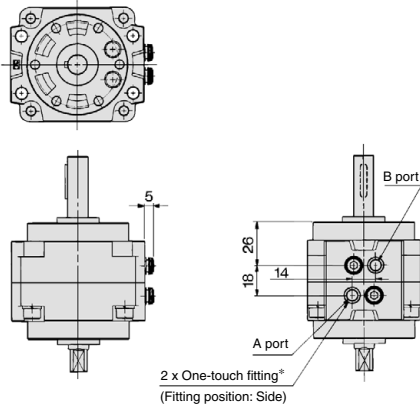

With auto switch

CDRB1□W50F-□□□

<Port location: Side ported>

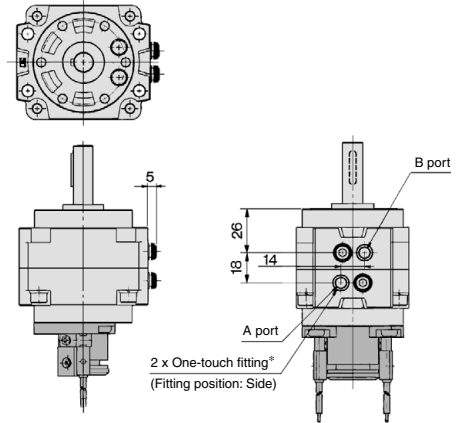

CRB1□W50F-□□E

<Port location: Axial ported>

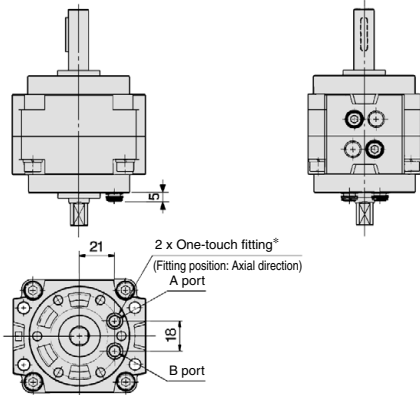

CDRB1□W50F-□□E-□

<Port location: Axial ported>

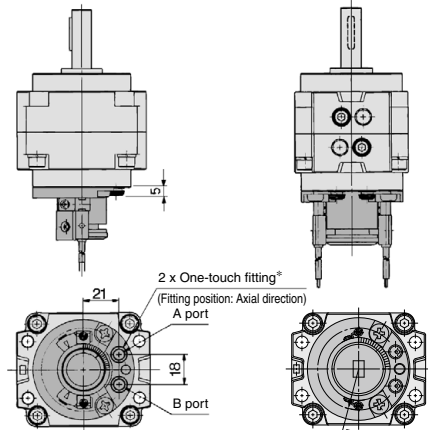

D-M9□

Applicable Tubing and O.D./I.D

Applicable tubing O.D./I.D [mm]	ø6/ø4
Applicable tubing material	Nylon, Soft nylon, Polyurethane

* Dimensions not indicated in the above figures are the same as size 50 actuator.

* Keys in the figures above show the intermediate rotation position for single vane type.

Rotary Actuator with Solenoid Valve

CVRB1 Series

Size: 50, 63, 80, 100

How to Order

Rotary Actuator

Rotary **CDVRB1 B W 80 - 90 S - M9B L** - **Made to Order**

For details, refer to pages 124 to 126, 133 and 134.

Auto switch

Nil	Basic type
D	With auto switch (With auto switch unit and built-in magnet)

Mounting

B	Basic
L	Foot

Size

50
63
80
100

Shaft type

W	Double shaft (Long shaft key & Four chamfers)
----------	---

Rotating angle

90	90°
100	100°
180	180°
190	190°
270	270°
280	280°

Vane type

S	Single vane
D	Double vane

Auto switch

Nil	Without auto switch (Built-in magnet)
M	Without D-M9 type auto switch (Built-in magnet)

Number of auto switches

S	1 pc.*
Nil	2 pcs.**

* S: A right-hand auto switch is shipped.
** Nil: A right-hand switch and a left-hand switch are shipped.

Electrical entry/Lead wire length

Nil	Grommet/Lead wire: 0.5 m
M	Grommet/Lead wire: 1 m
L	Grommet/Lead wire: 3 m
CN	Connector/Without lead wire
CL	Connector/Lead wire: 0.5 m
CL	Connector/Lead wire: 3 m

How to Order (Example)

When ordering the rotary actuator with solenoid valve, CVRB1 series, specify the models of both the rotary and the valve (solenoid valve).

(Note) For the valve, add * in front of the part number when ordering.

(Example) CDVRB1BW80-90S-R73 ---1 pc.
*VZ5140-5LZ1 pc.

* For applicable auto switch model, refer to the table below.
** The operating range and hysteresis of the D-M9□ are different from those of the other auto switches. For details, refer to page 135.

Solenoid Valve

Valve **VZ 3 1 40 - 5 L** - **X199**

Valve series

3	VZ3000 series	□ VVRB1BW50,63
5	VZ5000 series	□ VVRB1BW80,100

Type of actuation

1	2-position single solenoid
2	2-position double solenoid

Rated voltage

1	100 VAC 50/60 Hz
2	200 VAC 50/60 Hz
5	24 VDC

Electrical entry

Grommet	L plug connector	M plug connector	DIN terminal
G: Lead wire length 300 mm	L: With lead wire (Wire length: 300 mm)	M: With lead wire (Wire length: 300 mm)	D: With connector
H: Lead wire length 600 mm	LO: Without connector	MO: Without connector	DO: Without connector

Manual

Nil: Non-locking push type **B:** Locking B type (Slotted)

C: Locking C type (Manual)

Light/Surge voltage suppressor

Nil	Without light/surge voltage suppressor
S	With surge voltage suppressor
Z (Note)	With light/surge voltage suppressor

Note) GZ, HZ and DOZ are not available.

Applicable Auto Switches/Refer to pages 797 to 850 for further information on auto switches.

Type	Special function	Electrical entry	Indicator light	Wiring (Output)	Load voltage		Auto switch model		Lead wire type	Lead wire length [m]					Pre-wired connector	Applicable load
					DC	AC	Perpendicular	In-line		0.5 (Nil)	1 (M)	3 (L)	5 (Z)	None (N)		
Solid state auto switch	Grommet	Connector	Yes	3-wire (NPN) 3-wire (PNP) 2-wire 3-wire (NPN) 3-wire (PNP)	24 V	5 V,	—	M9NV M9PV M9BV	M9N M9P M9B	Oilproof heavy-duty cord	●	●	●	○	—	IC circuit
						12 V					●	●	○	—		
						12 V					●	●	○	—		
						5 V,					●	●	○	—		
						12 V					●	●	○	—		
						12 V					●	●	○	—		
Reed auto switch	Grommet Connector Connector	No	Yes	2-wire	—	100 V	100 V	R73 R73C R80 R80C	—	●	●	●	○	—	Relay, PLC	
						48 V, 100 V				●	●	○	—			
						100 V				●	●	○	—			
						24 V or less				●	●	○	—			
						—				●	●	○	—			
						—				●	●	○	—			

* Lead wire length symbols:
0.5 m Nil (Example) R73C
3 m L (Example) R73CL
5 m Z (Example) R73CZ
None N (Example) R73CN

* Solid state auto switches marked with "○" are produced upon receipt of order.

CVRB1 Series

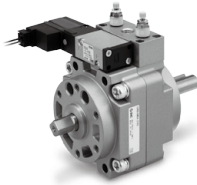

Made to Order

(For details, refer to pages 124 to 126, 133 and 134.)

Symbol	Description
XA1 to XA24	Shaft type pattern
XC1	Addition of connection port
XC4	Change of rotating angle
XC5	Change of rotating angle
XC6	Change of rotating angle
XC7	Reversed shaft
XC26	Change of rotating angle
XC27	Change of rotation range and direction
XC30	Fluorine grease

Refer to pages 135 to 137 for actuators with auto switches.

- Auto switch unit and switch block unit
- Operating range and hysteresis
- How to change the auto switch detecting position
- Auto switch mounting
- Auto switch adjustment

Solenoid Valve Specifications

Model		VZ3000/5000 series	
Manual override		Non-locking push type Locking type (Slotted), Locking type (Manual)	
Pilot exhaust type		Pilot valve individual exhaust	
Mounting position		Free	
Impact/Vibration resistance [m/s²] <small>Note 1)</small>		300/50	
Enclosure		Dusttight	
Electrical entry		Grommet (G)/(H), L plug connector (L), M plug connector (M), DIN terminal (D)	
Coil rated voltage [V]	AC 50/60 Hz	100, 200	
	DC	24	
Allowable voltage fluctuation [%]		-15 to +10 of rated voltage	
Power consumption [W] [Current mA] <small>Note 2)</small>		DC	1.8 (With light: 2.1) (24 VDC: 75 [With light: 87.5])
Apparent power [VA] <small>Note 2)</small> [Current mA]	AC	Inrush	4.5 to 50 Hz, 4.2/60 Hz <small>[100 VAC: 45/50 Hz, 42/60 Hz; 200 VAC: 22.5/50 Hz, 21/60 Hz]</small>
		Holding	3.5/50 Hz, 3/60 Hz <small>[100 VAC: 35/50 Hz, 30/60 Hz; 200 VAC: 17.5/50 Hz, 15/60 Hz]</small>
Surge voltage suppressor		DC: Diode, AC: ZNR	
Indicator light		DC: LED (Red), AC: Neon bulb	

* Option

Note 1) Impact resistance: No malfunction occurred in the impact test using a drop impact tester. The test was performed at both energized and de-energized states to the axis and right angle direction of the main valve and armature.

Note 2) Vibration resistance: No malfunction occurred in the one-sweep test between 45 and 2000 Hz. A test was performed at both energized and de-energized states to the axis and right angle direction of the main valve and armature. (Value in the initial stage.)

Note 2) At the rated voltage.

About rotary actuator specifications

The vibration adjustment range differs from that of the standard series.

With solenoid valve: 0.3 to 1 s/90°

Other specifications and structures are similar to those of the standard CRB1 series. Refer to pages 111 and 116.

For details on how to calculate the moment of inertia, required torque, kinetic energy, etc., refer to the "Rotary Actuators Model Selection."

Model selection software is available. For details, refer to the "Model Selection Software" section on the SMC website.

Dimensions

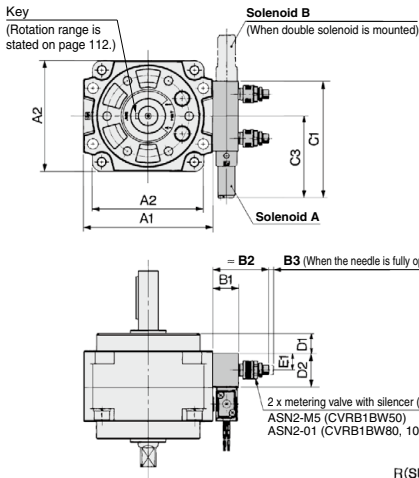

* Keys in the figures below show the intermediate rotation position for single vane type.

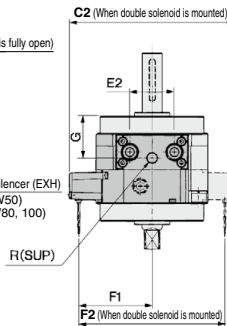

Note 1) Solenoid valve in external appearance is for VZ1140-G.

Note 2) Solenoid valve dimensions: 2-position single solenoid, (): 2-position double solenoid.

Size	A1	A2	B1	B2	B3	C1	C2	C3	D1	D2	E1	E2	F1	F2	G	R
50	78	67	18	36	2.8	82.5	120 (136.5)	60 (61)	12	24	11.5	30	52 (53)	104 (120.5)	25	1/8
63	98	82	18	36	2.8	88	102 (136.5)	60 (61)	16	24	11.5	30	52 (53)	104 (120.5)	27.5	1/8
80	110	95	22	48	4	100	140 (155)	70 (71)	17	29	14	38	62 (63)	124 (139)	36	1/8
100	140	125	22	48	4	100	140 (155)	70 (71)	23.5	29	14	38	62 (63)	124 (139)	42.5	1/8

CRB□2

CRB1

MSU

CRJ

CRA1

CRQ2

MSQ

MSZ

CRQ2X
MSQX

MRQ

D-□

CRB1 Series (Size: 50, 63, 80, 100)

Simple Specials

-XA1 to -XA24: Shaft Pattern Sequencing I

Shaft shape pattern is dealt with simple made-to-order system. (Refer to the front matter.)
Please contact SMC for a specification sheet when placing an order.

Symbol

-XA1 to XA24

Shaft Pattern Sequencing I

Applicable shaft type: W (Standard)

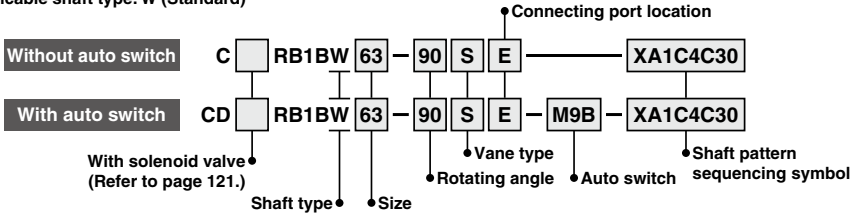

Shaft Pattern Sequencing Symbol

Note) The tolerance of the additionally machined parts conforms to the general tolerance.

● Axial: Top (Long shaft side)

Symbol	Description	Size			
		50	63	80	100
XA1	Shaft-end female thread	●	●	●	●
XA14*	Shaft through-hole + Shaft-end female thread	●	●	●	●
XA17*	Change of long shaft length (Change of key length)	●	●	●	●
XA24*	Double key	●	●	●	●

* The vane type for the shaft through-hole is compatible with single vanes only.

● Axial: Bottom (Short shaft side)

Symbol	Description	Size			
		50	63	80	100
XA2*	Shaft-end female thread	●	●	●	●
XA15*	Shaft through-hole + Shaft-end female thread	●	●	●	●
XA18*	Change of short shaft length	●	●	●	●

* The vane type for the shaft through-hole is compatible with single vanes only.

● Double Shaft

Symbol	Description	Size			
		50	63	80	100
XA13*	Shaft through-hole	●	●	●	●
XA16*	Shaft through-hole + Double shaft-end female threads	●	●	●	●
XA19*	Change of double shaft length	●	●	●	●
XA20*	Reversed shaft, Change of double shaft length	●	●	●	●

* The vane type for the shaft through-hole is compatible with single vanes only.
* The product with an auto switch is available only for XA1, 14, 17 and 24.

Combination

XA□ Combination

Symbol	Description	Axial direction		Combination													
		Up	Down	XA1	XA2	XA13	XA14	XA15	XA16	XA17	XA18	XA19	XA20	XA24			
XA1	Shaft-end female thread	●	—	●	—	—	—	—	—	—	—	—	—	—	—	—	—
XA2	Shaft-end female thread	—	●	—	●	—	—	—	—	—	—	—	—	—	—	—	—
XA13	Shaft through-hole	●	—	—	—	—	—	—	—	—	—	—	—	—	—	—	—
XA14	Shaft through-hole + Shaft-end female thread	●	—	—	—	—	—	—	—	—	—	—	—	—	—	—	—
XA15	Shaft through-hole + Shaft-end female thread	—	●	—	—	—	—	—	—	—	—	—	—	—	—	—	—
XA16	Shaft through-hole + Double shaft-end female threads	●	—	—	—	—	—	—	—	—	—	—	—	—	—	—	—
XA17	Change of long shaft length (Change of key length)	—	●	—	—	—	—	—	—	—	—	—	—	—	—	—	—
XA18	Change of short shaft length	—	●	—	—	—	—	—	—	—	—	—	—	—	—	—	—
XA19	Change of double shaft length	—	●	—	—	—	—	—	—	—	—	—	—	—	—	—	—
XA20	Reversed shaft, Change of double shaft length	—	●	—	—	—	—	—	—	—	—	—	—	—	—	—	—
XA24	Double key	●	—	—	—	—	—	—	—	—	—	—	—	—	—	—	—

A total of two XA□ combinations is available.
Example: XA1A24

XA□, XC□ Combination

Combination other than -XA□, such as Made to Order (-XC□), is also available. Refer to pages 133 to 134 for details about made-to-order specifications.

Symbol	Description	Size	XA1, XA2 XA13 to 20, 24
XC1	Addition of connection port	50, 63 80, 100	●
XC4	Change of rotating angle		●
XC5	Change of rotating angle		●
XC6	Change of rotating angle		●
XC7	Reversed shaft		—
XC26	Change of rotating angle		●
XC27	Change of rotation range and direction		●
XC30	Fluorine grease		●

A total of four XA□ and XC□ combinations is available.
Example: XA1A24C1C30

Axial: Top (Long shaft side)

Symbol: A1 Machine female threads into the long shaft.

- The maximum dimension L1 is, as a rule, twice the thread size.
(Example) For M3: L1 = 6
- Applicable shaft type: W

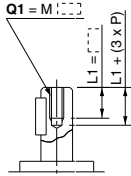

Size	Q1 [mm]
50	M3, M4, M5
63	M4, M5, M6
80	M4, M5, M6
100	M5, M6, M8

Symbol: A14 Applicable to single vane type only

A special end is machined onto the long shaft, and a through-hole is drilled into it. Female threads are machined into the through-holes, whose diameter is equivalent to the diameter of the pilot holes.

- The maximum dimension L1 is, as a rule, twice the thread size.
(Example) For M5: L1 = 10
- Applicable shaft type: W

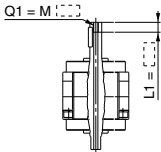

Size	50	63	80	100
Thread				
M5 x 0.8	ø4.2	ø4.2	ø4.2	—
M6 x 1	—	ø5	ø5	ø5
M8 x 1.25	—	—	—	ø6.8

Symbol: A17 Shorten the long shaft.

- Applicable shaft type: W

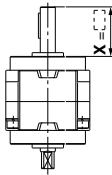

Size	X [mm]
50	24.5 to 39.5
63	28 to 45
80	30.5 to 53.5
100	40 to 65

Symbol: A24 Double key

Keys and keyways are machined at 180° of standard position.

- Applicable shaft type: W
- Equal dimensions are indicated by the same marker.

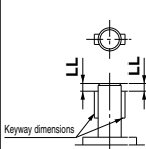

Size	Keyway dimension	LL [mm]
50	4 x 4 x 20	5
63	5 x 5 x 25	
80	5 x 5 x 36	
100	7 x 7 x 40	

Axial: Bottom (Short shaft side)

Symbol: A2 Machine female threads into the short shaft.

- The maximum dimension L2 is, as a rule, twice the thread size.
(Example) For M4: L2 = 8
- Applicable shaft type: W

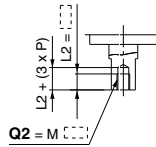

Size	Q2 [mm]
50	M3, M4, M5
63	M4, M5, M6
80	M4, M5, M6
100	M5, M6, M8

Symbol: A15 Applicable to single vane type only

A special end is machined onto the short shaft, and a through-hole is drilled into it. Female threads are machined into the through-hole, whose diameter is equivalent to the pilot hole diameter.

- The maximum dimension L2 is, as a rule, twice the thread size.
(Example) For M4: L2 = 8
- Applicable shaft type: W

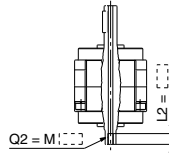

Size	50	63	80	100
Thread				
M5 x 0.8	ø4.2	ø4.2	ø4.2	—
M6 x 1	—	ø5	ø5	ø5
M8 x 1.25	—	—	—	ø6.8

Symbol: A18 Shorten the short shaft.

- Applicable shaft type: W

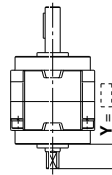

Size	Y [mm]
50	4 to 19.5
63	4 to 21
80	4 to 23.5
100	5 to 30

CRB2

CRB1

MSU

CRJ

CRA1

CRQ2

MSQ

MSZ

CRQ2X

MSQX

MRQ

D-□

Double Shaft

Symbol: A13

Applicable to single vane type only

Shaft with through-hole

- Minimum machining diameter for d1 is 0.1.
- Applicable shaft type: W

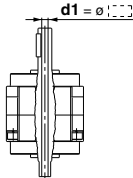

Size	d1	[mm]
50	ø4 to ø5	
63	ø4 to ø6	
80	ø4 to ø6.5	
100	ø5 to ø8	

Symbol: A16

Applicable to single vane type only

A special end is machined onto both the long and short shafts, and a through-hole is drilled into both shafts. Female threads are machined into the through-holes, whose diameter is equivalent to the diameter of the pilot holes.

- The maximum dimension L1 is, as a rule, twice the thread size.
- (Example) For M5: L1 = 10

• Applicable shaft type: W

• Equal dimensions are indicated by the same marker.

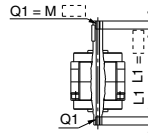

Size	50	63	80	100	[mm]
Thread					
M5 x 0.8	ø4.2	ø4.2	ø4.2	—	
M6 x 1	—	ø5	ø5	ø5	
M8 x 1.25	—	—	—	ø6.8	

Symbol: A19

Shorten both long and short shafts.

- Applicable shaft type: W

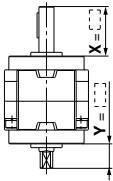

Size	X	Y	[mm]
50	24.5 to 39.5	4 to 19.5	
63	28 to 45	4 to 21	
80	30.5 to 53.5	4 to 23.5	
100	40 to 65	5 to 30	

Symbol: A20

The rotation axis is reversed.

(If shortening the shaft is not required, indicate "*" for dimension X, Y.)

- Applicable shaft type: W

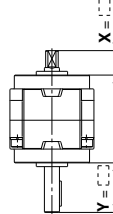

Size	X	Y	[mm]
50	4 to 19.5	24.5 to 39.5	
63	4 to 21	28 to 45	
80	4 to 23.5	30.5 to 53.5	
100	5 to 30	40 to 65	

CRB1 Series (Size: 50, 63, 80, 100)

Simple Specials

-XA31 to -XA60: Shaft Pattern Sequencing II

Shaft shape pattern is dealt with simple made-to-order system. (Refer to the front matter.)
Please contact SMC for a specification sheet when placing an order.

Symbol

Shaft Pattern Sequencing II

-XA31 to XA60

Applicable shaft type: J, K, S, T, X, Y, Z

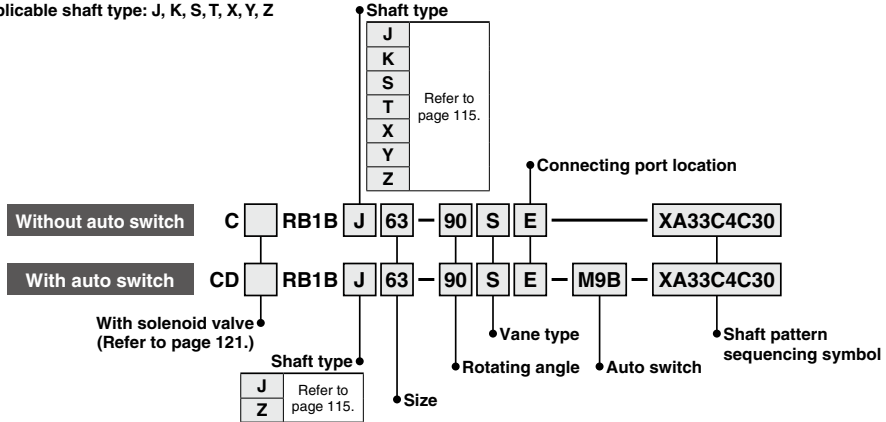

CRB1
 MSU
 CRJ
 CRA1
 CRQ2
 MSQ
 MSZ
 CRQ2X
 MSQX
 MRQ

Shaft Pattern Sequencing Symbol

● Axial: Top (Long shaft side)

Symbol	Description	Shaft type	Size
XA31	Shaft-end female thread	S, Y	50, 63, 80, 100
XA33	Shaft-end female thread	J, K, T	
XA35	Shaft-end female thread	X, Z	
XA37	Stepped round shaft	J, K, T	
XA45	Middle-cut chamfer	J, K, T	
XA48	Change of long shaft length (With keyway)	S, Y	100
XA51	Change of long shaft length (Without keyway)	J, K, T	
XA54	Change of long shaft length (With four chamfers)	X, Z	

● Axial: Bottom (Short shaft side)

Symbol	Description	Shaft type	Size
XA32	Shaft-end female thread	S, Y	50, 63, 80, 100
XA34	Shaft-end female thread	K, T	
XA36	Shaft-end female thread	J, X, Z	
XA38	Stepped round shaft	K	
XA46	Middle-cut chamfer	K	
XA49	Change of short shaft length (With keyway)	Y	100
XA52	Change of short shaft length (Without keyway)	K	
XA55	Change of short shaft length (With four chamfers)	J, Z	

● Double Shaft

Symbol	Description	Shaft type	Size
XA39*	Shaft through-hole	S, Y	50, 63, 80, 100
XA40*	Shaft through-hole	K, T	
XA41*	Shaft through-hole	J, X, Z	
XA42*	Shaft through-hole + Double shaft-end female threads	S, Y	
XA43*	Shaft through-hole + Double shaft-end female threads	K, T	
XA44*	Shaft through-hole + Double shaft-end female threads	J, X, Z	
XA50	Change of double shaft length (Both sides with keyway)	Y	
XA53	Change of double shaft length (Without keyway)	K	
XA56	Change of double shaft length (Both sides with four chamfers)	Z	
XA57	Change of double shaft length (With four chamfers, without keyway)	J	
XA58	Reversed shaft, Change of double shaft length (With four chamfers, without keyway)	J, T	
XA59	Reversed shaft, Change of shaft length (With four chamfers)	X	
XA60	Reversed shaft, Change of shaft length (With keyway)	S	

* The vane type for the shaft through-hole is compatible with single vanes only.
 * The product with an auto switch is available only for J and Z shafts of XA33, 35, 37, 45, 51 and 54.

D-□

Axial: Top (Long shaft side)

Symbol: A31 Machine female threads into the long shaft.

- The maximum dimension L1 is, as a rule, twice the thread size.
(Example) For M3: L1 = 6
- Applicable shaft type: S, Y

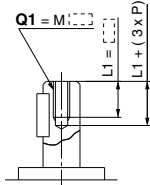

Q1 [mm]			
Size	S	Y	
50	M3, M4, M5		
63	M4, M5, M6		
80	M4, M5, M6		
100	M5, M6, M8		

Symbol: A33 Machine female threads into the long shaft.

- The maximum dimension L1 is, as a rule, twice the thread size.
(Example) For M3: L1 = 6
- Applicable shaft type: J, K, T

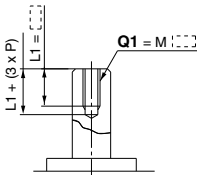

Q1 [mm]			
Size	J	K	T
50	M3, M4, M5, M6		
63	M4, M5, M6		
80	M4, M5, M6, M8		
100	M5, M6, M8, M10		

Symbol: A35 Machine female threads into the long shaft.

- The maximum dimension L1 is, as a rule, twice the thread size.
(Example) For M3: L1 = 6
- Applicable shaft type: X, Z

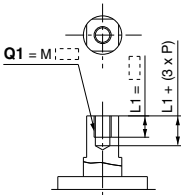

Q1 [mm]			
Size	X	Z	
50	M3, M4, M5		
63	M4, M5, M6		
80	M4, M5, M6		
100	M5, M6, M8		

Symbol: A37 The long shaft can be further shortened by machining it into a stepped round shaft.

- (If shortening the shaft is not required, indicate "*" for dimension X.)
(If not specifying dimension CA, indicate "*" instead.)
- Equal dimensions are indicated by the same marker.
- Applicable shaft type: J, K, T

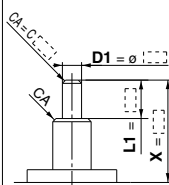

Size	X			L1 max			D1		
	J	K	T	J	K	T	J	K	T
50	4 to 39.5	X-3	3 to 11.9						
63	4 to 45	X-3	3 to 14.9						
80	4 to 53.5	X-3	3 to 16.9						
100	5 to 65	X-4	3 to 24.9						

Axial: Bottom (Short shaft side)

Symbol: A32 Machine female threads into the short shaft.

- The maximum dimension L2 is, as a rule, twice the thread size.
(Example) For M4: L2 = 8
- Applicable shaft type: S, Y

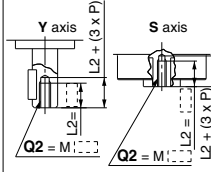

Q2 [mm]			
Size	S	Y	
50	M3, M4, M5, M6	M3, M4, M5	
63	M4, M5, M6	M4, M5, M6	
80	M4, M5, M6, M8	M4, M5, M6	
100	M5, M6, M8, M10	M5, M6, M8	

Symbol: A34 Machine female threads into the short shaft.

- The maximum dimension L2 is, as a rule, twice the thread size.
(Example) For M3: L2 = 6
- Applicable shaft type: K, T

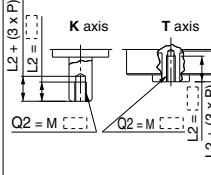

Q2 [mm]			
Size	K	T	
50	M3, M4, M5, M6		
63	M4, M5, M6		
80	M4, M5, M6, M8		
100	M5, M6, M8, M10		

Symbol: A36 Machine female threads into the short shaft.

- The maximum dimension L2 is, as a rule, twice the thread size.
(Example) For M3: L2 = 6
- Applicable shaft type: J, X, Z

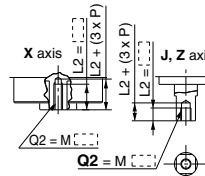

Q2 [mm]				
Size	X	J	Z	
50	M3, M4, M5, M6	M3, M4, M5		
63	M4, M5, M6	M4, M5, M6		
80	M4, M5, M6, M8	M4, M5, M6		
100	M5, M6, M8, M10	M5, M6, M8		

Symbol: A38 The short shaft can be further shortened by machining it into a stepped round shaft.

- (If shortening the shaft is not required, indicate "*" for dimension Y.)
(If not specifying dimension CB, indicate "*" instead.)
- Equal dimensions are indicated by the same marker.
- Applicable shaft type: K

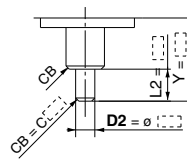

Size	Y		D2	
	L2 max		Y-3	3 to 11.9
50	4 to 39.5	Y-3	3 to 11.9	
63	4 to 45	Y-3	3 to 14.9	
80	4 to 53.5	Y-3	3 to 16.9	
100	5 to 65	Y-4	3 to 24.9	

CRB2
CRB1
MSU
CRJ
CRA1
CRQ2
MSQ
MSZ
CRO2X
MSQX
MRQ

D-□

CRB1 Series

Axial: Top (Long shaft side)

Symbol: A45 The long shaft can be further shortened by machining a middle-cut chamfer into it.
(The position of the chamfer is same as the standard one.)

(If shortening the shaft is not required, indicate "∞" for dimension X.)

- Minimum machining dimension is 0.1.
- Applicable shaft type: J, K, T

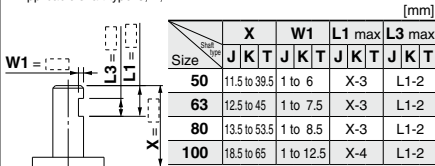

Symbol: A48 Shorten the long shaft.

- Applicable shaft type: S, Y

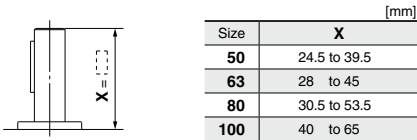

Symbol: A51 Shorten the long shaft.

- Applicable shaft type: J, K, T

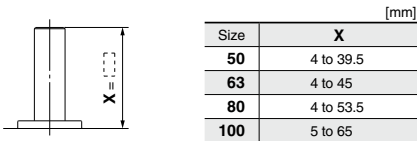

Symbol: A54 Shorten the long shaft.

- Applicable shaft type: X, Z

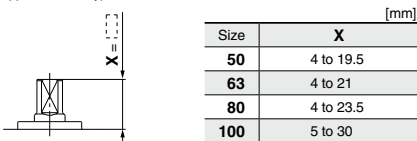

Axial: Bottom (Short shaft side)

Symbol: A46 The short shaft can be further shortened by machining a middle-cut chamfer into it.
(The position of the chamfer is same as the standard one.)

(If shortening the shaft is not required, indicate "∞" for dimension X.)

- Minimum machining dimension is 0.1.
- Applicable shaft type: K

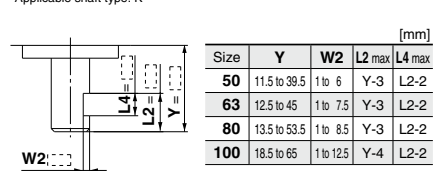

Symbol: A49 Shorten the short shaft.

- Applicable shaft type: Y

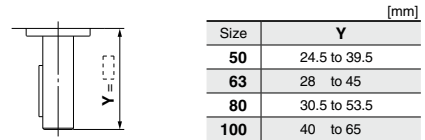

Symbol: A52 Shorten the long shaft.

- Applicable shaft type: K

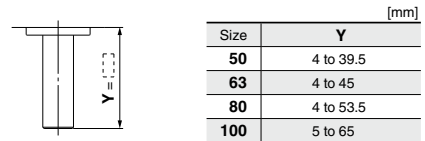

Symbol: A55 Shorten the short shaft.

- Applicable shaft type: J, Z

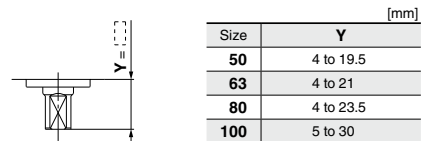

Symbol: A59 Reverse the assembly of the shaft, and shorten the long shaft.

- Applicable shaft type: X

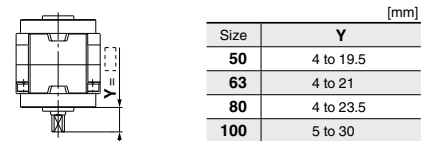

Symbol: A60 Reverse the assembly of the shaft, and shorten the long shaft.

- Applicable shaft type: S

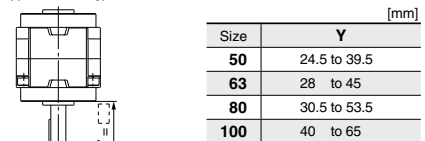

Caution

For the shaft patterns A45 and A46, a middle-cut chamfer may interfere with the center hole if the W1/W2 dimensions and (L1 - L3), (L2 - L4) dimensions are less than what are shown in the table below.

Size	[mm]			
	W1	W2	L1-L3	L2-L4
50	4.5 to 6		2 to 5.5	
63	6 to 7.5		2 to 3	
80	6.5 to 8.5		2 to 6.5	
100	10.5 to 12.5		2 to 6.5	

Double Shaft

Symbol: A39 Applicable to single vane type only

- Shaft with through-hole
 • Minimum machining diameter for d1 is 0.1.
 • Applicable shaft type: S, Y

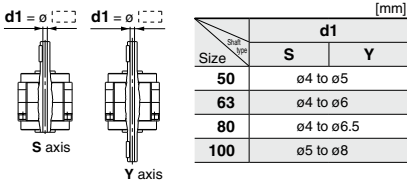

Symbol: A40 Applicable to single vane type only

- Shaft with through-hole
 • Minimum machining diameter for d1 is 0.1.
 • Applicable shaft type: K, T

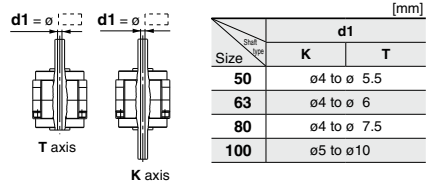

Symbol: A41 Applicable to single vane type only

- Shaft with through-hole
 • Minimum machining diameter for d1 is 0.1.
 • Applicable shaft type: J, X, Z

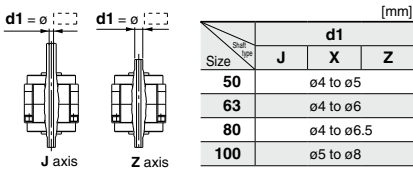

Symbol: A42 Applicable to single vane type only

- A special end is machined onto both the long and short shafts, and a through-hole is drilled into both shafts. Female threads are machined into the through-holes, whose diameter is equivalent to the diameter of the pilot holes.
 • The maximum dimension L1 is, as a rule, twice the thread size.
 • Applicable shaft type: S, Y • Equal dimensions are indicated by the same marker.

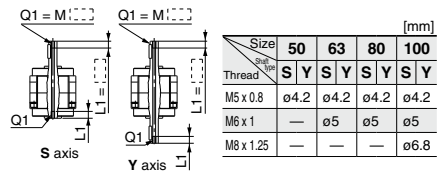

Symbol: A43 Applicable to single vane type only

- A special end is machined onto both the long and short shafts, and a through-hole is drilled into both shafts. Female threads are machined into the through-holes, whose diameter is equivalent to the diameter of the pilot holes.
 • The maximum dimension L1 is, as a rule, twice the thread size.
 • Applicable shaft type: K, T • Equal dimensions are indicated by the same marker.

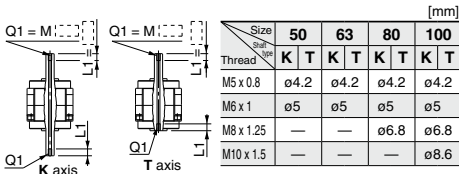

Symbol: A44 Applicable to single vane type only

- A special end is machined onto both the long and short shafts, and a through-hole is drilled into both shafts. Female threads are machined into the through-holes, whose diameter is equivalent to the diameter of the pilot holes.
 • The maximum dimension L1 is, as a rule, twice the thread size.
 • Applicable shaft type: J, X, Z • Equal dimensions are indicated by the same marker.

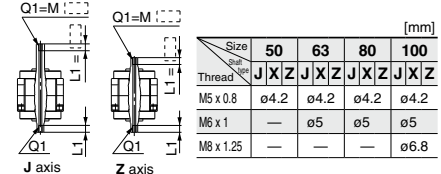

Symbol: A50 Shorten both long and short shafts.

- Applicable shaft type: Y

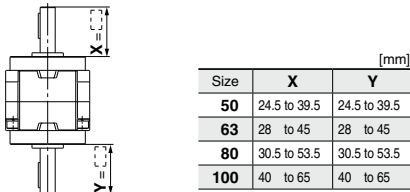

Symbol: A53 Shorten both long and short shafts.

- Applicable shaft type: K

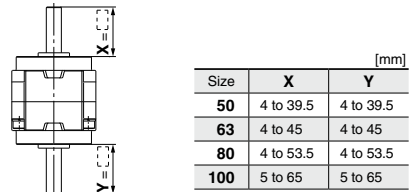

CRB2
CRB1
 MSU
 CRJ
 CRA1
 CRQ2
 MSQ
 MSZ
 CRQ2X
 MSQX
 MRQ

D-□

Double Shaft

Symbol: A56

Shorten both long and short shafts.

- Applicable shaft type: Z

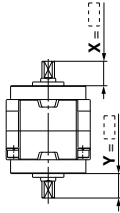

[mm]		
Size	X	Y
50	4 to 19.5	4 to 19.5
63	4 to 21	4 to 21
80	4 to 23.5	4 to 23.5
100	5 to 30	5 to 30

Symbol: A57

Shorten both long and short shafts.

- Applicable shaft type: J

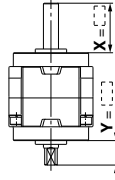

[mm]		
Size	X	Y
50	4 to 39.5	4 to 19.5
63	4 to 45	4 to 21
80	4 to 53.5	4 to 23.5
100	5 to 65	5 to 30

Symbol: A58

The rotation axis is reversed.

The long shaft and short shaft are shortened.

(If shortening the shaft is not required, indicate "*" for dimension X, Y.)

- Applicable shaft type: J, T

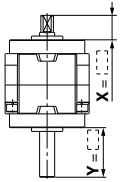

[mm]		
Size	X	Y
50	4 to 19.5	4 to 39.5
63	4 to 21	4 to 45
80	4 to 23.5	4 to 53.5
100	5 to 30	5 to 65

CRB1 Series (Size: 50, 63, 80, 100)

Made to Order

XC1, 4, 5, 6, 7, 26, 27, 30

How to Order

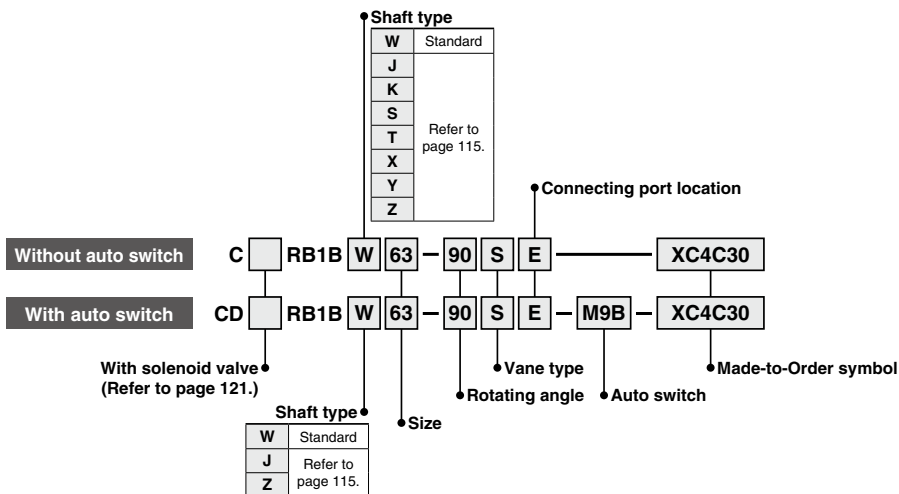

CRB1
CRB1
MSU
CRJ
CRA1
CRQ2
MSQ
MSZ
CRQ2X
MSQX
MRQ

Made-to-Order Symbol

Symbol	Description	Applicable shaft type	Size
		W, J, K, S, T, X, Y, Z	
XC1	Addition of connection port	●	50, 63, 80, 100
XC4	Change of rotating angle	●	
XC5	Change of rotating angle	●	
XC6	Change of rotating angle	●	
XC7*	Reversed shaft	●	
XC26	Change of rotating angle	●	
XC27	Change of rotation range and direction	●	
XC30	Fluorine grease	●	

* This specification is not available for rotary actuators with auto switch unit.

Combination

Symbol	Combination	
	XC1	XC30
XC1	—	●
XC4	●	●
XC5	●	●
XC6	●	●
XC7	●	●
XC26	●	●
XC27	●	●
XC30	●	—

Symbol: C1

Add connection ports on Body (A).
(An additionally machined port will have an aluminum surface since it will be left unfinished.)

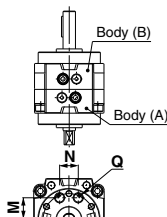

Symbol: C4

Change of rotating angle. (Applicable to single vane type only)
Start of rotation is horizontal line (90° down from the top to the right side).

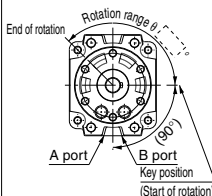

CRB1 Series

Symbol: C5

Change of rotating angle. (Applicable to single vane type only)
Start of rotation is 45° up from the bottom of the vertical line to the left side.

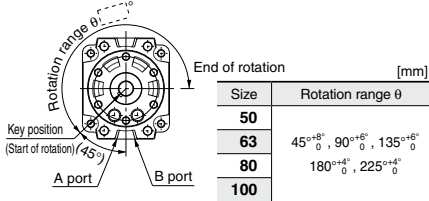

Start of rotation is the position of the key when B port is pressurized.
(Top view from long shaft side)

Symbol: C7

The shafts are reversed.

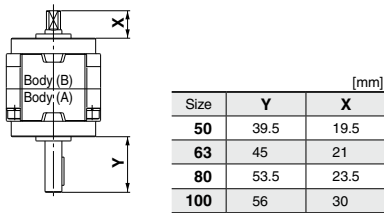

Symbol: C27

Change of rotating angle. (Applicable to double vane type only)
Rotating angle 90° Start of rotation is 45° up from the bottom of the vertical line of the right side.

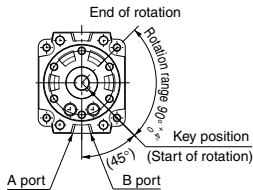

Start of rotation is the position of the key when A port is pressurized.
(Top view from long shaft side)

Symbol: C6

Change of rotating angle. (Applicable to single vane type only)
Start of rotation is horizontal line (90° down from the top to the left side).

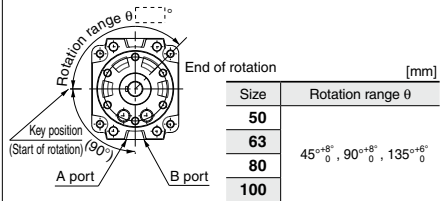

Start of rotation is the position of the key when B port is pressurized.
(Top view from long shaft side)

Symbol: C26

Change of rotating angle. (Applicable to single vane type only)
Start of rotation is 45° up from the bottom of the vertical line to the right side.

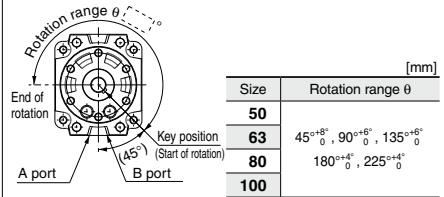

Start of rotation is the position of the key when A port is pressurized.
(Top view from long shaft side)

Symbol: C30

Change the standard grease to fluorine grease.
(Not for low-speed specification.)

CRB1 Series Auto Switch Mounting

Auto Switch Unit and Switch Block Unit

Unit Part Number

Size	For D-M9□		For D-S/T79□, D-R73/80□		
	Auto switch unit part number*1	Switch block unit part number Common to right-hand and left-hand	Auto switch unit part number*1	Switch block unit part number*2	
				For right-hand	For left-hand
50	P411020-1M	P811010-8M	P411020-1	P411020-8	P411020-9
63	P411030-1M		P411030-1	P411040-8	P411040-9
80	P411040-1M		P411040-1		
100	P411050-1M		P411050-1		

*1 An auto switch will not be included, please order it separately.

*2 Auto switch unit comes with one right-hand and one left-hand switch blocks that are used for addition or when the switch block is damaged.

Operating Range and Hysteresis

* Operating range: θm

The range between the position where the auto switch turns ON as the magnet inside the auto switch unit moves and the position where the auto switch turns OFF as the magnet travels the same direction.

* Hysteresis range: θd

The range between the position where the auto switch turns ON as the magnet inside the auto switch unit moves and the position where the auto switch turns OFF as the magnet travels the opposite direction.

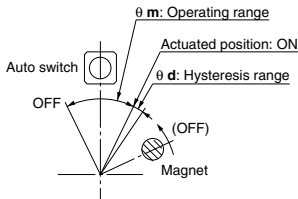

D-M9□

Size	θm : Operating range	θd : Hysteresis range
50	86°	10°
63, 80, 100	70°	10°

D-S/T79□, D-R73/80□

Size	θm : Operating range	θd : Hysteresis range
50	52°	8°
63, 80, 100	38°	7°

Note) Since the figures in the above table are provided as a guideline only, they cannot be guaranteed. Adjust the auto switch after confirming the operating conditions in the actual setting.

How to Change the Auto Switch Detecting Position

* When setting the detecting position, loosen the cross recessed round head screw a bit and move the auto switch to the preferred position and then tighten again and fix it. At this time, if tightened too much, screw can become damaged and unable to fix position. Proper tightening torque: 0.4 to 0.6 [N·m] When tightening the cross recessed round head screw, take care that the auto switch does not tilt.

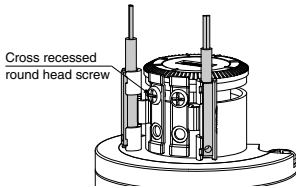

D-M9□
Size: 50 to 100

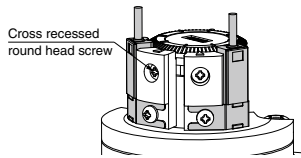

D-S/T79□
D-R73/R80□
Size: 50 to 100

CRB□2

CRB1

MSU

CRJ

CRA1

CRQ2

MSQ

MSZ

CRQ2X
MSQX

MRQ

D-□

CRB1 Series

Auto Switch Mounting

External view and descriptions of auto switch unit

The following shows the external view and typical descriptions of the auto switch unit.

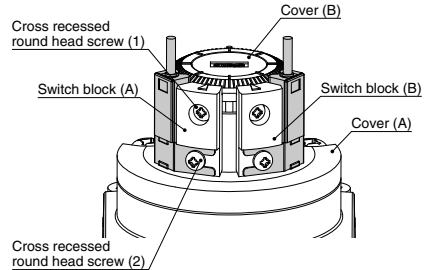
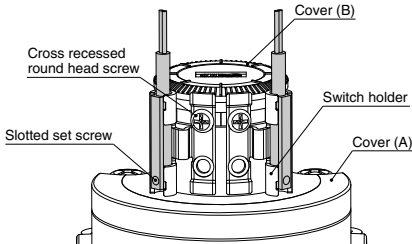

Mounting Procedure

<Applicable auto switch>

Solid state auto switch

D-M9□

1. Auto switch mounting

Insert the auto switch into the groove of the switch holder.

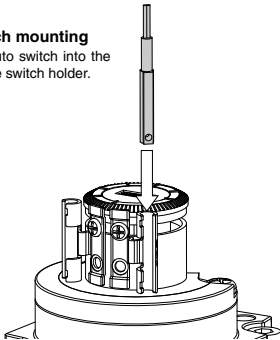

2. Auto switch securing

Align the auto switch with the lower surface of the groove on the side of the switch holder, and secure the slotted set screw. (Refer to the enlarged view.)

* Proper tightening torque: 0.05 to 0.1 [N·m]

Align with the groove lower surface to secure.

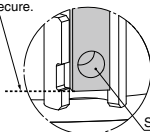

Enlarged view

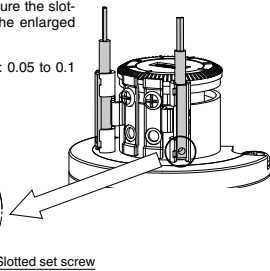

3. Switch holder securing

After the actuated position has been adjusted with the cross recessed round head screw, use the auto switch.

* When tightening the screw, take care that the auto switch does not tilt.

Mounting Procedure

<Applicable auto switch>

Solid state auto switch

D-S79, S7P

D-T79, T79C

Reed auto switch

D-R73/R73C (With indicator light)

D-R80/R80C (Without indicator light)

1. Auto switch mounting

Loosen the cross recessed round head screw (2), and insert the arm of the auto switch.

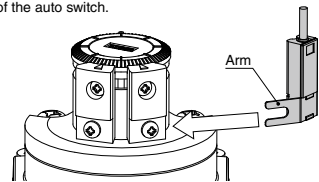

2. Auto switch securing

Set the auto switch so that it is in contact with the switch block, and tighten the cross recessed round head screw (2).

* Proper tightening torque: 0.4 to 0.6 [N·m]

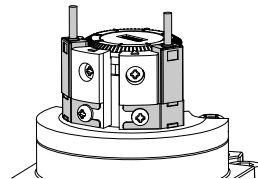

3. Switch holder securing

After the actuated position has been adjusted with the cross recessed round head screw (1), use the auto switch.

* Proper tightening torque: 0.4 to 0.6 [N·m]

Auto Switch Adjustment

Rotation range of the output shaft key (keyway) and auto switch mounting position

<Applicable models / Size: 50, 63, 80, 100>

<Single vane>

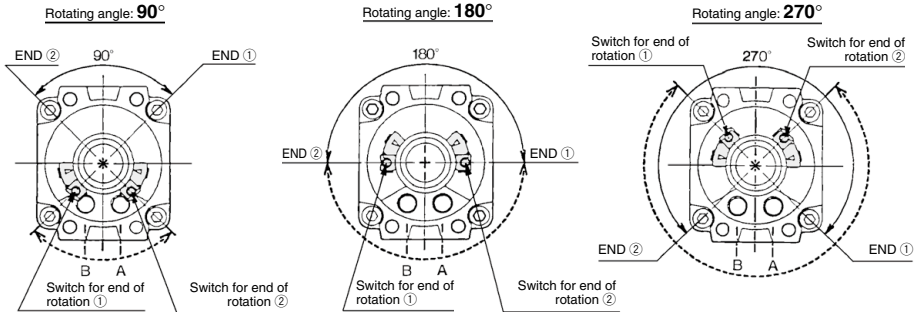

- * Solid-lined curves indicate the rotation range of the output key (keyway). When the key is pointing to end of rotation ① the switch for end of rotation ① will operate, and when the key is pointing to end of rotation ②, the switch for end of rotation ② will operate.
- * Broken-lined curves indicate the rotation range of the built-in magnet. Rotation range of the switch can be decreased by either moving the switch for end of rotation ② clockwise or moving the switch for end of rotation ② counterclockwise. Auto switch in the figures above is at the most sensitive position.
- * Each auto switch unit comes with one right-hand and one left-hand switch.
- * The magnet position can be checked with a convenient ► indication by removing a rubber cap when adjusting the auto switch position.
- * For standard products, a magnet is mounted on the opposite side of the output shaft key.
- * Since four chamfers are machined into the axis of rotation, a magnet position can be readjusted at 90° intervals.

<Double vane>

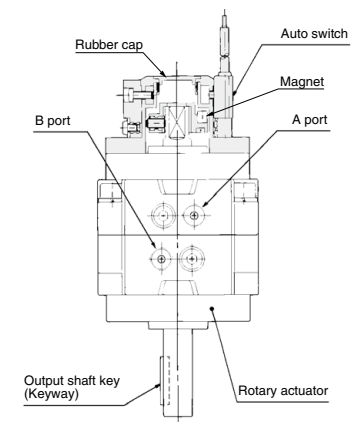
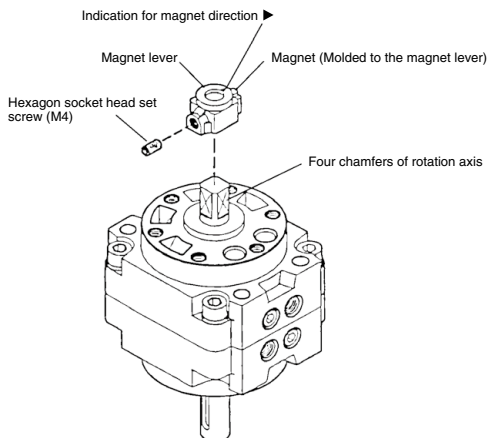
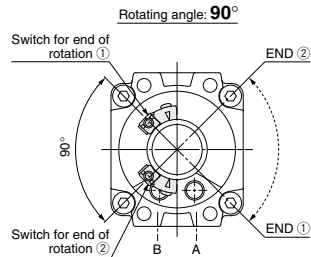

CRB□2
CRB1
MSU
CRJ
CRA1
CRQ2
MSQ
MSZ
CRQ2X
MSQX
MRQ

D-□